



Motor Testing & Sensors

Torque Sensors, Brakes & Clutches
Dynamometers, Electronics & Fixtures,
Custom Motor Test Systems & Solutions
Data Acquisition & Testing Software



MAGTROL INC.

Magtrol, Inc. located in Buffalo, New York, USA, is the company's headquarters as well as a manufacturing facility. Founded in 1953 by John E. Duncan, a pioneer in magnetic hysteresis phenomena, the company quickly gained recognition in the field of measurement technology.

Since then, Magtrol Inc. has continued to innovate and become a world-class leader in Motor Testing Solutions, Hysteresis Brakes & Clutches.



MAGTROL S.A.

Magtrol S.A. is located in Rossens, Switzerland. Founded in 1952, the company evolved from the Instrumentation Division of Vibro-Meter (today Meggitt S.A.).

In 2000, Magtrol Inc. acquired this division and founded Magtrol S.A. The acquisition was a valuable addition to the company adding its expertise in torque measurement (essential for Motor Testing), Dynamometers, Custom Motor Test Systems, and also Load-Force-Weight measurement solutions and Displacement measurement.

Magtrol Group



William A. III MULROY
President



Tom RYMARCZYK
CEO Magtrol, Inc.



Jocelyn CATTIN
CEO Magtrol SA

For more than 60 years, Magtrol Group has been developing and producing high-tech transducers and systems for a wide range of applications, including testing and certification of electric motors, torque measurement (motors, pumps, drives, gearboxes, etc.), force and load measurement (cranes, hoists, mechanical lifts, civil engineering anchors, etc.) and displacement measurement in control systems. The company serves a variety of fields including but not limited to household appliances, automotive, aeronautics, test or research laboratories, medical, power generation, harbor cranes, transportation, civil engineering.

Since its founding, customer service has been a priority at Magtrol. The company utilizes our expertise to offer specific solutions ranging from custom sensors to customized turnkey systems.

Our innovative R&D department regularly expands our offerings by developing new products and creative solutions.

Our products are exported to most countries throughout the world providing a worldwide presence and reputation widely recognized by all professionals in the field. Despite our international activity, Magtrol Group reinforces the foundation of our success through the involvement of our employees and the support of the local economic environment.

Magtrol is committed to being involved in the local economy through collaborations with research and training organizations. Our core values allow the company to benefit from hard-working, experienced and dedicated employees who contribute to the continued success of Magtrol.

TABLE OF CONTENT

Torque Sensors	4
In-Line Torque Sensors	6
Torque Flange Sensors	8
Reaction Torque Sensors	9
Cogging Torque System	10
Display, Electronics & Software	11
Customize your own Torque System !	13
Torque Calibration Laboratory	14
Industrial Brakes	16
Power Supplies	23
Dynamometers	24
Hysteresis Brake Dynamometers	26
Eddy-Current Dynamometers	28
Powder Dynamometers & TANDEM	30
Mega Speed Dynamometer	32
4Q Dynamometers	33
Electronics & Software	34
System Options & Accessories	38
Couplings	40
MMTS Modular Motor Test Systems	42
Custom Motor Test Benches & Systems	44
Services, Consulting & Support	46



LOAD-FORCE-WEIGHT SOLUTIONS

Magtrol designs complete measurement systems from transducers to conditioning electronics. These solutions provide high-precision static and dynamic measurement and can be used in various fields, including: micro-measurement (medical, watchmaking), heavy industrial equipment for overload detection and control (hoists, cranes, winches, ski lifts,...), civil engineering (anchors), etc. Our solutions can be adapted to any type of environment including extreme conditions, such as tropical, offshore, harbor,...



CUSTOM MOTOR TEST SYSTEMS

Magtrol has distinguished itself in its ability to design and implement innovative motor test systems. With more than 60 years of experience, the company offers fully customized test bench systems. These can be configured to be used in a laboratory, certification, production or quality control. Magtrol offers widely recognized expertise to meet a multitude of requirements, whether it's for series testing, extreme specifications or special climatic environments.



DISPLACEMENT TRANSDUCERS

Magtrol has specialized in non-contact displacement transducer technology. With their rugged construction, insensitivity to shock and long life, these transducers allow high precision measurements in extreme environments (temperature, pressure, abrasive,...). Jointly developed for the hydraulic industry, these sensors are used in hydraulic cylinders, control valves, steam inlet valves, stone crushers, boat engines and propellers,...

Torque Sensors

Magtrol's torque transducers are very high precision devices. Whether static or rotating (with speed measurement), they are designed for laboratory testing, certification of production components, or monitoring of equipment. When mounted and used in conjunction with brakes and dynamometers as well as measuring electronics, they constitute a particularly efficient and versatile test bench.

	MODEL	RATED TORQUE								Max. SPEED	ACCURACY	SPEED	ANGLE	ANGLE REF.	OUTPUT
		0.01N-m	0.1N-m	1N-m	10N-m	100N-m	1kN-m	10kN-m	100kN-m						
ROTATING SHAFT	TS Series	0.02 N-m		500 N-m					15 000 rpm	0.05 ... <0.10 %	x	x	x	±5VDC (±10VDC) + USB	
	TM Series	0.1 N-m		10 000 N-m					20 000 rpm	<0.1 ... <0.15 %	x			±5VDC (±10VDC)	
	TMB Series	1 N-m		500 N-m					6 000 rpm	<0.1 %	x			±5VDC (±10VDC)	
	TMHS Series	0.5 N-m		10 000 N-m					50 000 rpm	<0.1 ... <0.15 %	x			±5VDC (±10VDC)	
FLANGE	TF Series			20 N-m		100 000 N-m			17 000 rpm	0.05 ... 0.20 %	(x)			±5VDC (±10VDC)	
	TFHS Series			20 N-m		10 000 N-m			20 000 rpm	0.05 ... 0.20 %	(x)			±5VDC (±10VDC)	
STATIC	RT 100 Series			200 N-m		100 000 N-m			N/A	0.05 ... 0.20 %	N/A			0.5 ... 1 mV/V	
	RT 200 Series	0.02 N-m		100 N-m					N/A	0.05 ... 0.20 %	N/A			0.5 ... 1 mV/V	



ROBUST AND ACCURATE IN-LINE TORQUE TRANSDUCERS

Torque Sensor development and manufacturing have been a part of our production range since the origin of the company in 1952. Over the years, Magtrol has continued to build on our core technology to meet the needs of an ever changing global market.

Today, Magtrol's in-line torque transducers have achieved a leading position in the torque measurement market.

Our sensors are internationally renowned for their high stability and reliability over time. Magtrol's torque transducers offer the highest overload capability on the market. Our standard transducers have a speed range capability of up to 50 000 rpm.

As a global competitor, Magtrol Group provides complete solutions, from stand-alone sensors with couplings to displays and acquisition software to meet your testing needs.

OPEN LOOP SYSTEM

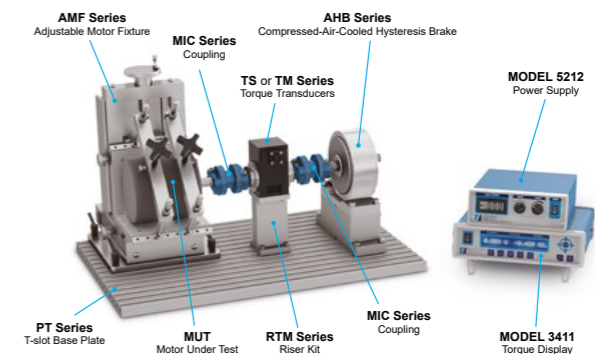

Magtrol offers both open loop manual test systems and PC-based closed loop test systems. A characteristic of the open-loop system is that it does not use feedback to determine if its input has achieved the desired goal. This means that the system does not react to the output of the processes that it is controlling. An open-loop controller is often used in simple test setups because of its simplicity and low cost, especially in systems where feedback is not critical and can be adjusted manually. The above example shows an open-loop system where the torque is manually set by the MODEL 5212 Power Supply and simply read on the MODEL 3411 Torque Display.

CLOSED LOOP SYSTEM

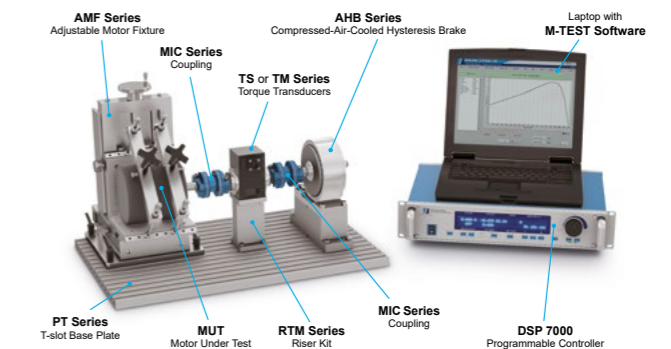

In a closed loop motor test system, the feedback is automatically read and used to determine if its input has achieved the desired set point. This means that the system reacts to the output of the processes that it is controlling. A closed-loop controller is often used because of its ability to repeatedly return to a desired controlled point. In the above example of a closed-loop system, DSP 7000 Programmable Dynamometer Controller will constantly adjust the current applied to the brake to best reach the desired set parameters. Adding M-TEST Software will allow to run test cycles in close loop mode, compute and records testing data, display the measured parameters and curves or issue a test report.

TS SERIES Torque Sensors

Lastest generation of In-Line Torque Transducers



ELECTRICAL CONFIGURATION

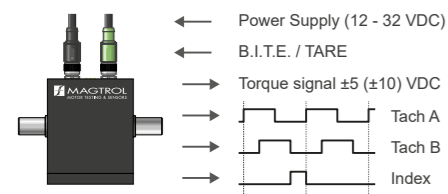

TS Series Torque Sensors deliver both an isolated USB interface and an analog output signal. Both signals can be utilized simultaneously, e.g. one channel for data acquisition and the other for closed-loop control of the drive line.

The sensor integrates a 360, 400 or 720 PPR (Pulses Per Revolution) encoder allowing an angular resolution up to 0.25° and offering a reference index (1 Pulse Per Revolution).

Encoders with 1 000 or 5 000 PPR (available on request), further improve the angular resolution if required.

SYSTEM STATUS INDICATORS



A system consisting of three color LEDs continuously informs the user about the operating status of the device. The USB interface allows a direct connection with a computer to perform tests with our free dedicated TORQUE software.

Magtrol's TS Series In-Line Torque Sensors provide extremely accurate torque and speed measurement. Each model has an integrated conditioning electronic module providing $\pm 5\text{VDC}$ ($\pm 10\text{VDC}$) torque output through an 8-pole connector, as well as a USB interface which can be directly connected to a computer.

SENSOR RATINGS			
MODEL	NOMINAL RATED TORQUE (RT)	MAX SPEED	ENCODER RESOLUTION
	N·m	rpm	PPR ^{a)}
TS 199	0.02	150	5000
TS 100	0.05	15000	360
TS 101	0.1		
TS 102	0.2		
TS 103	0.5		
TS 104	1		
TS 105	2		
TS 106	5		
TS 107	10	8000	400
TS 109	20		
TS 110	50		
TS 111	100	6000	720
TS 112	200		
TS 113	500		

SPECIFICATIONS	
Maximum Dynamic Torque Peak Value	200 % of RT
Maximum Static Torque Without Damage	300 % of RT
Combined Error of Linearity & Hysteresis	< 0.1 % of RT (0.05% on request)
Operating Temperature	-25 ... +80 °C
Power Supply (voltage range / max. power)	12 ... 32VDC / < 2.2W (24VDC recommended)
Analog Torque Output (rated / max.)	$\pm 5\text{V} / \pm 10\text{V}$ (max. output current 2 mA)
Torque Signal Bandwidth (-3 dB) controlled by USB command.	2 Hz / 5 Hz / 10 Hz / 20 Hz / 50 Hz / 100 Hz / 1000 Hz
Tach Outputs & Index	TTL, max. output current 5 mA

ANGLE MEASUREMENT			
MODEL	TS 100 - TS 107	TS 109 - TS 111	TS 112 - TS 113
Speed & Angle Measurement	360 PPR ^{a, b)} 2 signals, 90° phase shift (quadrature X4) + Index Optical Encoder	400 PPR ^{a, b)}	720 PPR ^{a)}
Angle Resolution (USB)	0.25°	0.225°	0.125°
Accuracy (over 360°)	$\pm 0.25^\circ$	$\pm 0.225^\circ$	$\pm 0.125^\circ$

a) PPR means Pulse Per Revolution

b) 1000 PPR (speed limit 5000 rpm) or 5000 PPR (speed limit 1000 rpm) available on request

TM SERIES In-Line Torque Transducers

Reliable, accurate, proven and highly tolerant Torque Sensors



Magtrol's In-Line Torque Transducers provide extremely accurate torque and speed measurement over a very broad range. Each model has an integrated conditioning electronic module providing a $\pm 5\text{VDC}$ ($\pm 10\text{VDC}$) torque output and an open collector speed output. Magtrol Torque Transducers are very reliable, providing high over-load protection, excellent long term stability and high noise immunity.

TRANSDUCER RATINGS					
MODEL ^{a)}	NOMINAL RATED TORQUE (RT) N·m	ACCURACY CLASS	MAX. SPEED		
			rpm		
			TMB	TM	TMHS
TM 301	0.1	0.2%	N/A	20000	N/A
TM 302	0.2	<0.1%			40000
TM 303	0.5	<0.1%			50000
TM 304	1.0	<0.1%	6000	10000	32000
TM 305	2.0	<0.1%			24000
TM 306	5.0	<0.1%			16000
TM 307	10	<0.1%	4000	7000	12000
TM 308	20	<0.1%			5000
TM 309	20	<0.1%			12000
TM 310	50	<0.1%	N/A	5000	16000
TM 311	100	<0.1%			12000
TM 312	200	<0.1%			16000
TM 313	500	<0.1%	N/A	5000	12000
TM 314	1000	<0.1%			16000
TM 315	2000	<0.1%			12000
TM 316	5000	<0.1%	N/A	5000	12000
TM 317	10000	<0.15%			12000

FIXATION FOR TM 301 - 308

Magtrol has redesigned the mounting system for its small torque transducers (TM 301-308). The new mounting base allows not only installation of the torque transducers from below as before, but also installation from the top.

It also integrates a centering key underneath its housing. The old fastening system (from below only) is still available as an alternative.

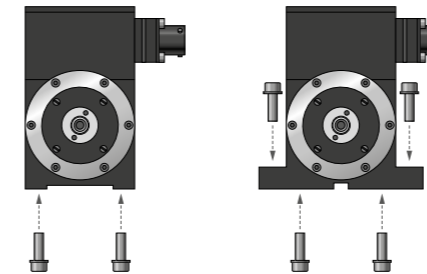

On the left the narrow housing allows fastening from bottom only. On the right, the new housing allows fastening from top and bottom.

SPECIFICATIONS	
Maximum Dynamic Torque Peak Value	0 ... $\pm 200\%$ of RT
Maximum Dynamic Torque Without Damage	0 ... $\pm 400\%$ of RT ($\pm 200\%$ for TM 317)
Combined Error of Linearity & Hysteresis	$< \pm 0.1\%$ of RT ($< \pm 0.15\%$ for TM 317)
Operating Temperature	-40 ... +85 °C
Power supply (max. voltage / current)	20 ... 32VDC / 100 mA
Torque output (rated / max.)	$\pm 5\text{VDC} / \pm 10\text{VDC}$
Filter Cutoff (frequency)	5000, 2500, 1000, 500, 200, 100, 40, 20, 10, 5, 2, 1 Hz
Speed output (frequency)	open collector (15 Ω in series), max. 30VDC, protected against short circuits

a) Model definition is either TM, TMB or TMHS depending on speed range

A UNIQUE MEASURING PRINCIPLE

The measuring system, based on the principle of a variable, torque proportional transformer coupling, consists of two slotted concentric cylinders shrunk on the shaft on each side of the shaft's deformation zone, and two concentric coils attached to the housing. When torque is applied, the deformation zone undergoes an angular deformation and the

slots begin to overlap, varying the transformer ratio which after amplification and filtering provides the torque signal. The main advantage of having only mechanic components in rotation (no electronic parts, no gauges, no wire nor welding spot in rotation), is that the system will have very high speed capability and high reliability.

TF SERIES Torque Flange Sensors

Easy to install, non-contact measurement, highly resistant



WIRELESS TRANSMISSION

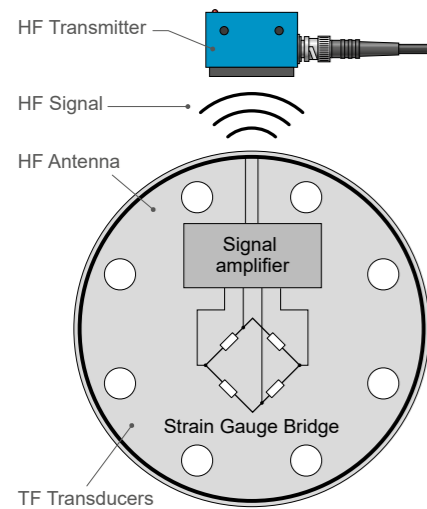

The antenna pickup (or HF Transmitter) of the Magtrol Torque Flange sensor is very small and easy to position in the test bench installation.

It is a point to point transmission which does not require a complete surrounding antenna nor a big transmission base.

The gap between the pickup antenna and the sensor is about 1-3 mm. This provides more flexibility and facilitates the installation of the transducer.

With its compact, bearingless, maintenance-free design, the TF Torque Flange Sensor from Magtrol brings many appealing advantages to torque measurement applications. The TF's high torsional rigidity supports direct mounting on the machine shaft or flange, avoiding the use of couplings on one side. This allows easy integration into a test system, shortens the overall length of the test bench and reduces costs.

SENSOR RATINGS

MODEL ^{a)}	NOMINAL RATED TORQUE (RT)	ACCURACY CLASS	MAXIMUM SPEED
	N-m		rpm
TF 309 / TFHS 309	20	0.1 %	17 000 / 20 000
TF 310 / TFHS 310	50	0.1 %	
TF 311 / TFHS 311	100	0.1 % ^{b)}	
TF 312 / TFHS 312	200	0.1 % ^{b)}	15 000 / 20 000
TF 313 / TFHS 313	500	0.1 % ^{b)}	
TF 314 / TFHS 314	1000	0.1 % ^{b)}	
TF 315 / TFHS 315	2000	0.1 % ^{b)}	12 000 / 20 000
TF 316 / TFHS 316	5000	0.1 % ^{b)}	10 000 / 15 000
TF 317 / TFHS 317	10 000	0.1 % ^{b)}	10 000 / 12 000
TF 318	20 000	0.1-0.2 %	3 500
TF 319	50 000	0.1-0.2 %	
TF 320	100 000	0.1-0.2 %	

a) Torque up to 150 kN-m or higher, and high speed versions are available on request

b) Linearity-hysteresis error 0.05% is available on request

SPECIFICATIONS

Maximum Dynamic Torque Peak Value	200 % of RT
Maximum Dynamic Torque Without Damage	400 % of RT
Combined Error of Linearity & Hysteresis	< 0.1 % of RT (0.05% on request)
Rated Temperature Range	+10 ... +85 °C
Extended Temperature Range (option)	-30 ... +125 °C
Protection class	IP42 (option IP54)
Power Supply	24 VDC ±10 %, max 350 mA TF 318, TF 319 & TF 320: 100-240 VAC
Torque Output Signal (rated / max.)	±5 VDC / ±10 VDC
Filter Bandwidth	0-1 kHz (-3 dB) / (option 5 kHz)
Speed Output (option)	TTL ^{a)}

OPTION & ACCESSORIES

Speed sensors (option)	Available through specific speed sensor
High temperature capability (option)	Up to +125 °C

a) Pulse per revolution correspond with number of teeth

RT SERIES Reaction Torque Sensors

Compact and robust transducer for static torque measurement



SEVERE & MINIATURE APPLICATIONS

The product is available in 2 ranges:

RT 100 Series, with flange mounting and designed for higher torque range; and the more compact **RT 200 Series**, with shaft mounting and dedicated to smaller torque range.

The RT 100 Reaction Torque Sensor offers a central through-hole allowing the passing of a shaft, pneumatic or hydraulic pipes, wiring, or any other tool.

With its compact, robust and maintenance-free design, the Magtrol RT Series Reaction Torque Sensor has many favorable features. Based on strain-gauge technology, this Sensor provides highly accurate signal transmission. The RT Series Torque Sensor has been designed to perform static torque measurement and dynamic rotation (with limited angle) in both clockwise and counterclockwise direction with high precision.

SENSOR RATINGS

RT 100 Series			RT 200 Series		
MODEL	STATIC RATED TORQUE (RT)	ACCURACY CLASS	MODEL	STATIC RATED TORQUE (RT)	ACCURACY CLASS
	N-m	%		N-m	%
RT 112	200	0.05	RT 299	0.02	0.20
RT 113	500		RT 200	0.05	
RT 114	1 000		RT 201	0.1	
RT 115	2 000	0.10	RT 202	0.2	0.05
RT 116	5 000		RT 203	0.5	
RT 117	10 000		RT 204	1	
RT 118	20 000	0.20	RT 205	2	0.10
RT 119	50 000		RT 206	5	
RT 120	100 000 ^{a)}		RT 207	10	
		0.25	RT 209	20	0.10
			RT 210	50	
			RT 211	100 ^{a)}	

a) Higher capacity on request

SPECIFICATIONS

MODEL	RT 100 Series	RT 200 Series
Overload capacity	200 % of RT	
Max. static torque	350 ... 400 % of RT	300 % of RT
Combined Error of Linearity & Hysteresis	0.05 ... 0.25 % of RT	0.05 ... 0.2 % of RT
Nominal temperature range	+20 ... +60 °C	
Service temperature range	-20 ... +85 °C	+10 ... +80 °C
Reference temperature	+23 °C	
Protection class	IP65	IP42
Input resistance	700 Ω	1 000 Ω
Power supply	0.5 ... 12 VDC (max. 15 VDC)	
Torque output signal	0.5 ... 1 mV/V	

PSD - PORTABLE SENSOR DISPLAY

This device is very compact, light and easy to use. The amplifier can process sensor strain gauge signals ±0.3 ... 5 mV/V. High measuring accuracy, paired with fast measuring rates allows an internal resolution of 22 bits at 2 mV/V. It also stores the adjustment data, sensor designation and physical unit. Functions, such as TARE, recall of min/max Value, etc. are available during the measurement. More info: www.magtrol.com



CTS SERIES Cogging Torque System

Smart All-in-One System to analyze cogging torque on motor



Magtrol's Cogging Test System is a stand-alone test system designed to control and measure Detent Torque, Cogging Torque and Friction Torque. The test System includes a precision geared motor and a TS Series Torque Sensor integrating a 5000 pulse encoder. **CTS-Test Software** (included) controls the system and displays acquired data. It provides accurate peak-to-peak measurement of cogging torque and displays X-Y or polar graphs as well as FFT analysis. The software allows the storage of measured data and provides comparison of performance data by overlaying up to 5 graphs.

As a stand-alone system, the CTS only requires 100~240VAC power. A USB interface allows direct connection to the PC on which the software is installed. It is mounted on a PT-25 grooved base plate on which the motor fixture can be fitted. Vertical mounting brackets are available as an option, allowing the system to be mounted in vertical position, which is recommended for very low measuring values.

Model CTS 100 - 102 can easily be scaled up or down (50, 100 or 200 mN·m), simply by replacing the TS Sensor which is mounted in front of the unit. The software will recognize the torque sensor in use and will automatically adapt its measuring range.

CUSTOMISE YOUR REPORT

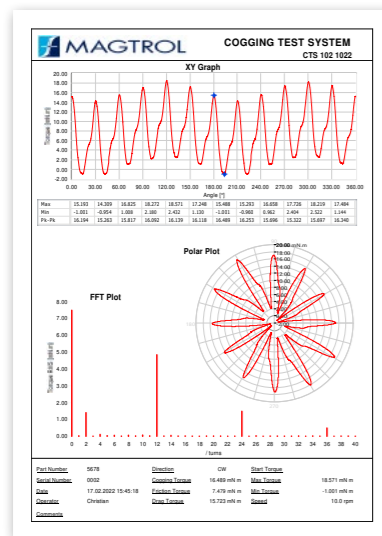

Above is an example of a compiled report that can be used as a certificate. In addition to the measured data, the report can contain X-Y, polar and FFT graphs.

SPECIFICATIONS						
MODEL	CTS 100	CTS 101	CTS 102	CTS 103	CTS 104	CTS 105
Rated Torque (RT) ^{a)}	50 mN·m	100 mN·m	200 mN·m	500 mN·m	1 N·m	2 N·m
Accuracy	0.2% of RT		0.1% of RT			
Scalability of the measuring range	Yes			No		
Speed range	1 ... 10 rpm ^{b)}					
Angle detection	0.018° (5000 PPR ^{c)})					
Direction of rotation	Clockwise (CW) & Counter Clockwise (CCW)					
Operating temperature range	+10 ... +45 °C					
Power supply	100 ~ 240 VAC / 50 ~ 60 Hz (max. 1A)					
Connection interface	USB 2.0					

a) Other ranges are available on request

c) PPR means «Pulse Per Revolution»

b) Other speeds are available on request.

WHAT ABOUT COGGING TESTING ?

The Drag Torque or Detent Torque is an important parameter in permanent magnet (PM) motors, especially in a PM servo motor system. Detent Torque of PM motors is composed of Cogging Torque and Friction Torque.

The **Cogging Torque** is generated by attraction/interaction of the magnetic poles to the teeth (steel structure) within an un-energized motor. It is one of the most important parameters of permanent magnet motors, which causes torque ripple, vibration and noise. Generally the cogging torque varies with rotor position and is defined by its peak to peak value.

The **Friction Torque** is attributed to mechanical assembly issues, such as bearing resistance, assembly tolerance, or carbon-brush friction for brush PM DC motors. Friction Torque is commonly measured by its average value.

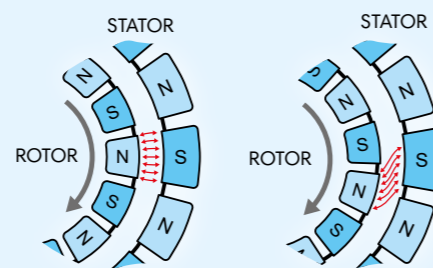

When the magnets are face-to-face (left), the force is maximized. When the motor is running (right), the moving magnetic elements will first have to free themselves from the residual magnetism before proceeding to the next step. This resistance to advancement is named cogging.

MODEL 3411 Torque Display

Versatile and portable torque display device



ULTIMATE LABORATORY DEVICE



With its compact size and portability, the MODEL 3411 - Torque Display is the perfect partner for mobile or laboratory work.

In addition to the standard stand alone version, the Torque Display is also available in a Rack Mountable version (RMK) as well as in a portable version (HDL) with adjustable handle.

Magtrol's MODEL 3411 - Torque Display is designed for use with all Magtrol TS, TM, TMHS, TMB and TF Torque Transducers. This easy-to-use device powers the transducer and utilizes high speed processing to display torque, speed and mechanical power. It includes a tare function to help offset any slight residuals caused by couplings or suspended loads. The MODEL 3411 may also be used with any torque sensors requiring 24VDC power (500 mA max.) with ± 5 VDC torque output (± 10 VDC max.) and open collector, TTL or CMOS output for the speed signal.

- High Quality, Easy-to-Read Vacuum Fluorescent Readout: Displays torque, speed and power
- Addition of high resolution quadrature encoder enables low RPM applications or position measurements
- Selectable English, Metric and SI Torque Units
- Isolated USB Interface
- Ethernet connectivity
- Torque: Analog, raw sensor output
- Speed output; analog or digital, user selectable
- B.I.T.E. (Built-In Test Equipment)
- Overload Indication
- TARE Function
- Includes Magtrol TORQUE Software
- High Speed Data Acquisition: Up to 500 torque and speed points per second with time stamp
- Rack mount or handle versions available

SPECIFICATIONS

Maximum Input Speed	199 999 rpm
Maximum Input Frequency	199 999 Hz
Speed Accuracy	0.01 % of reading 5 ... 199 999 rpm
Torque Accuracy	0.02 % of range (± 10 V)
Voltage Requirements	120 ~ 240 VAC / 60 ~ 50 Hz
Power Requirements	36 VA
Sensor Power Available (through the 14-pin Connector)	5 VDC 200 mA, fused internally at 500 mA 24 VDC 500 mA, short circuit protected
Transducer Input Speed / Angle	Open Collector, 5VHC, TTL, CMOS
Transducer Input Torque	± 10 VDC max
Torque Output BNC	± 10 VDC (direct from transducer)
Speed Output BNC	5VHC pulse (buffered from transducer) or ± 10 VDC analog
Operating Temperature	+5 ... +50 °C

TSB Torque & Speed Box

To allow power & connection for up to 2 Torque Sensors



The TSB Torque & Speed Box provides power supply for up to 2 TM Series or TS Series Torque Transducers in parallel. It also provides a ± 5 V analog output for torque and TTL output for speed (60 PPR) for TM Series and a single track TTL output for speed (with number of PPR, Pulse Per Revolution according to the torque sensor).

The outputs can be connected respectively to a voltmeter and frequency meter. It supplies power for up to 2 Torque Sensors (TM or TS Series) at the same time.

- Torque analog output: ± 5 V (± 10 V) for connection to data acquisition system or an analog input display
- TTL output (speed)
- Power supply: 100/240 VAC, 50/60 Hz

TORQUE Measurement Software

User-friendly software for quick torque measurements

Magtrol's TORQUE Software is an easy to use Windows® executable program, used to automatically collect torque, speed, mechanical power and angle data from Magtrol TS & TM Series Torque Sensors or Magtrol TF Series Torque Flange Sensors by using MODEL 3411 Torque Display. The data can be printed, displayed graphically or quickly saved/exported as a Microsoft® Excel spreadsheet.

- New graphical user interface has user friendly tabbed pages and menus for quick navigation
- Multi-Language support (English, German, French)
- TS Series In-Line Torque Sensors support via USB
- MODEL 3411 Torque Transducer Display support via USB and LAN
- Measured Parameter vs. Time
- Adjustable Sampling Rates
- Multi-Axes Graphing
- Optional USB Device support for reading thermocouples
- Angle parameter available with TS Series and MODEL 3411

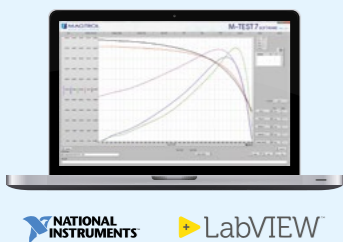
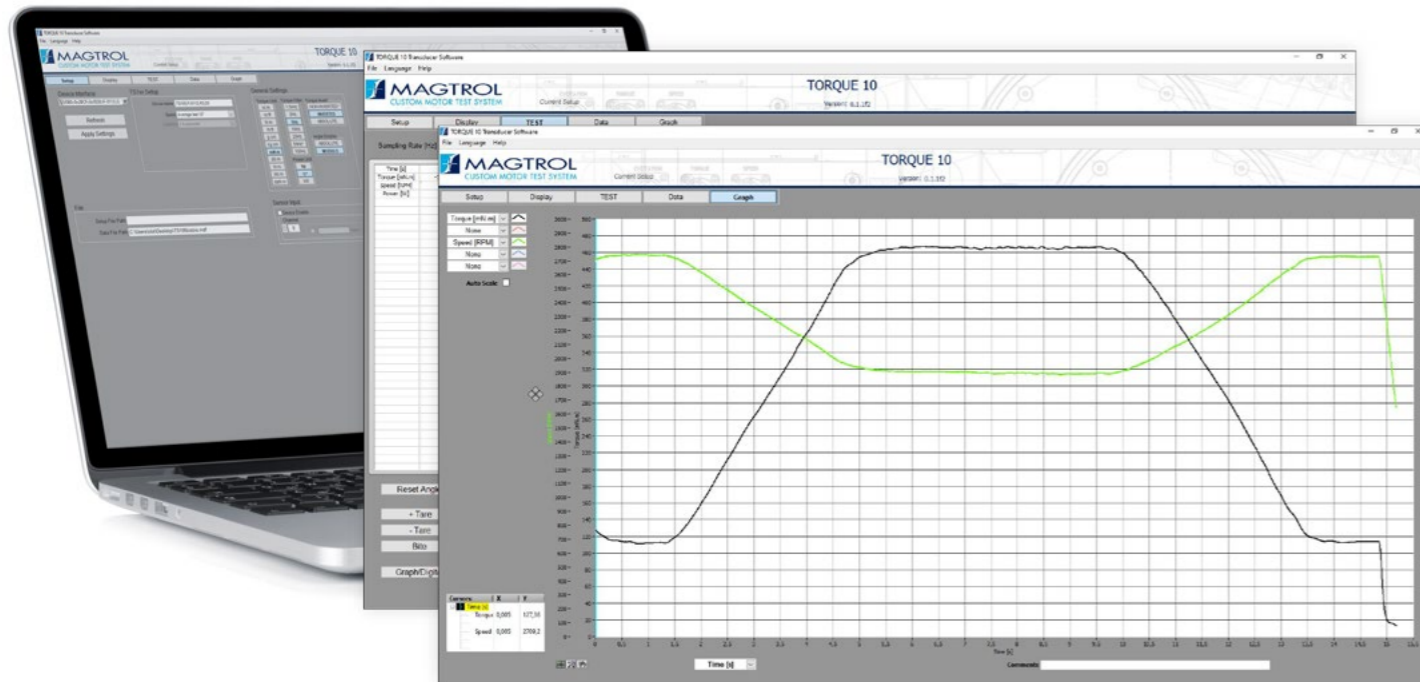

LABVIEW™ BASED SOFTWARE

Magtrol's Softwares are state-of-the-art motor testing program for Windows®-based data acquisition. For example, used with a Magtrol Programmable Dynamometer Controller, Magtrol M-TEST Software provides the control of any Magtrol Dynamometer and runs test sequences in a manner best suited to the overall accuracy and efficiency of the Magtrol Motor Test System. The data that is generated by Magtrol's Softwares can be stored, displayed and printed in tabular or graphic formats, and also can be easily imported into a spreadsheet.

CUSTOMIZE YOUR OWN TORQUE SYSTEM !

Magtrol Torque Sensors can be connected in various configurations. It can be used independently (via an external power supply) or in combination with other Magtrol devices (e.g. DSP 7000 - High-Speed Dynamometer Controller, MODEL 3411 - Torque Display,...).

The sensors can be used with Magtrol software, such as M-TEST or TORQUE (included), to allow the data to be acquired and displayed.

The double signal output, analog and USB, can be used simultaneously. For example, one channel for data acquisition and the other one for closed loop control of a drive line.

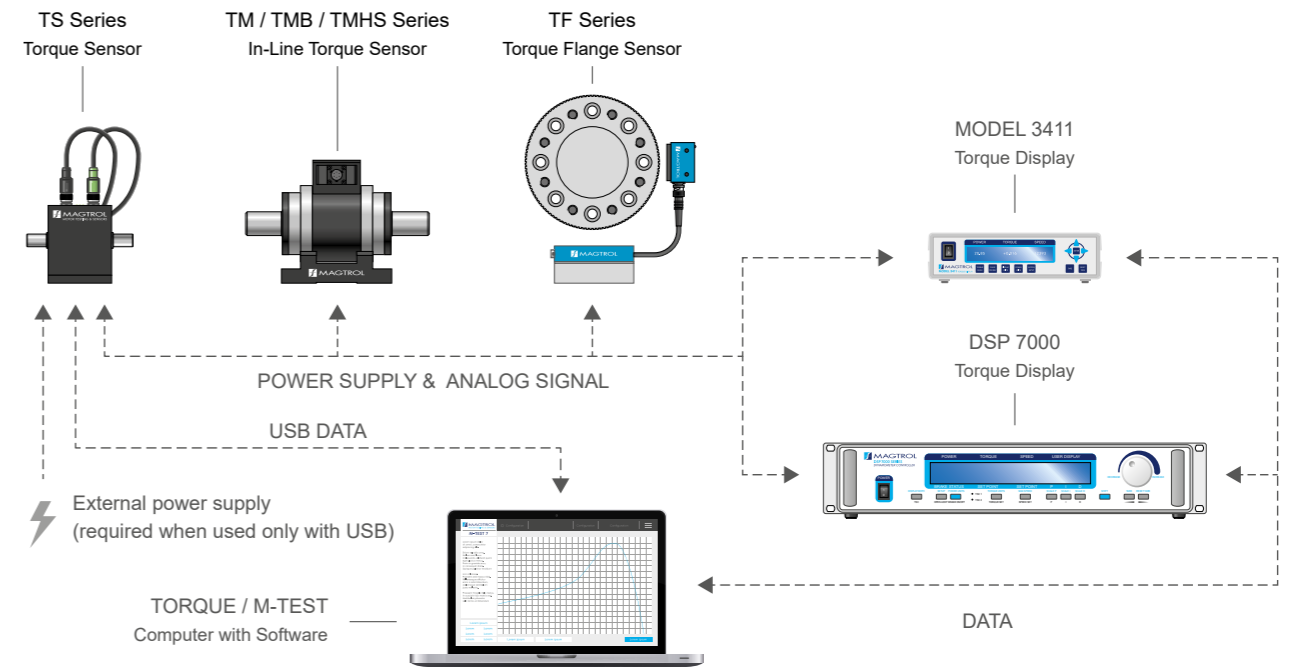

Configuration for rotating torque sensors measurement

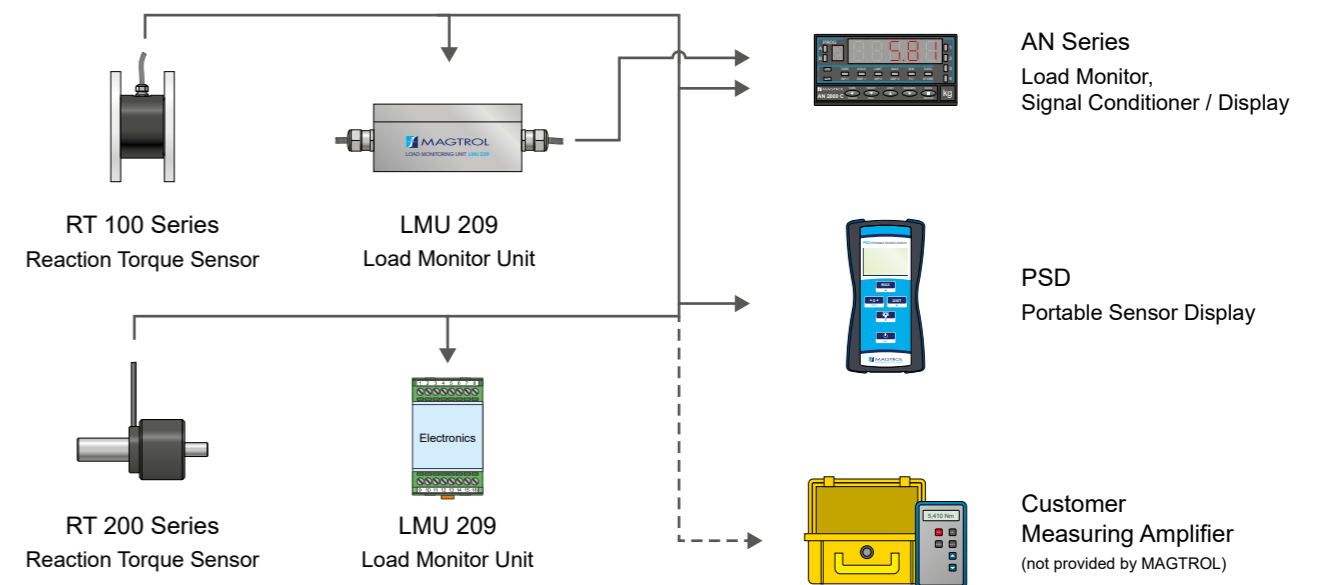

Configuration for static torque sensors measurement

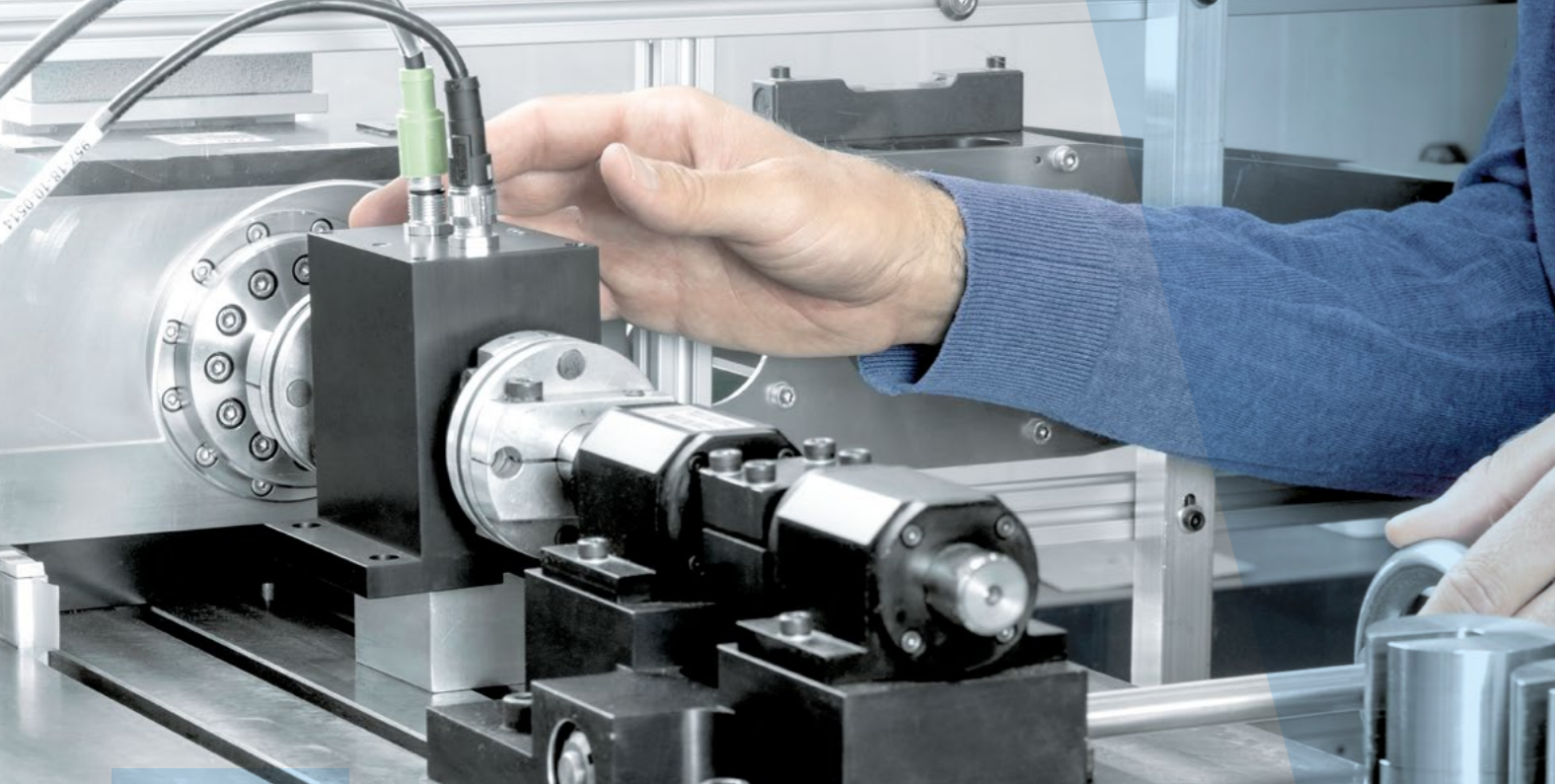

LABORATORY'S GENERAL FEATURES

- In-house torque calibration from 100mN·m to 50000N·m
- Accredited by SAS (Swiss Accreditation Service), NIST equivalent *
- Best Measurement Uncertainty of 0.01 %
- Calibration of any torque sensor brand
- Calibration according to Euramet cg14 method or Factory Calibration method by «Magtrol» **
- Fast Turn-Around-Time (TAT), providing calibration time has been pre-determined.

* Magtrol's calibration laboratory is internationally recognized by ilac-MRA (International Laboratory Accreditation Cooperation - Mutual Recognition Arrangement). As SAS being a co-signatory of ilac-MRA, this guarantees the equivalence with an accredited organization like COFRAC, DAKKS, UKAS, A2LA, ANAB, NVLAP, ... (please see the list of signatories on www.ilac.org)

** Calibration is possible using a guideline-based Euramet cg-14 method or according to a method based on Magtrol's experience. Magtrol's calibration method is similar to the factory certificate provided by Magtrol, but it is accredited and applies only to Magtrol products.

Torque Calibration Laboratory

ISO / IEC 17025 Accredited Calibration Laboratory

ISO / IEC17025 accreditation is a recognition of laboratory expertise and a guarantee of quality for the calibration procedure of MAGTROL Torque Sensors; TS, TM, TMB, TMHS, TF & RT Series. MAGTROL also offers calibration services for all torque sensors, regardless of the manufacturer.

MAGTROL torque calibration laboratory consists of three lever calibration benches covering a range 0.1 ... 5.000N·m as well as a motorized gear bench covering a range 1000 ... 50000N·m.

The measurement uncertainties of calibration benches are up to 0.01% of the measured torque value. The laboratory was designed and built to meet metrological requirements, eliminating floor vibration and temperature fluctuations that may interfere with measurements.

Since 2020, our Torque Laboratory has been accredited for the calibration of WB & PB Series Dynamometers. This allows Magtrol to ensure that all elements of a measurement chain (e.g. WB/PB Dynamometer + DES Power Supply + TSC Conditioner + DSP 7000 Controller) are fully calibrated.



Configuration for rotating torque sensors measurement



Magtrol's calibration laboratory is internationally recognized by ilac-MRA (International Laboratory Accreditation Cooperation - Mutual Recognition Arrangement). As SAS being a co-signatory of ilac-MRA, this guarantees the equivalence with an accredited organization like COFRAC, DAKKS, UKAS, A2LA, ANAB, NVLAP, ... (please see the list of signatories on www.ilac.org).

Calibration is possible using a guideline based Euramet cg-14 method or according to a method based on Magtrol's experience. Magtrol's calibration method is similar to the factory certificate provided by Magtrol, but it is accredited and applies only to Magtrol products.



20... 5000 N·m Frictionless Calibration System using double lever and calibrated weights.

CALIBRATION SYSTEMS

Frictionless Calibration System using double lever and calibrated weights.

- Product: In-Line Rotating & Reaction Torque Sensors.
 Throughput time: 5-10 days
 Accreditation: ISO/IEC 17025 / SCS 0139
 Range: 0.1 ... 5000N·m
 Best Uncertainty: ± 0.03%, range 0.1 ... 1 N·m
 ± 0.02%, range 1 ... 50N·m
 ± 0.01 %, range 20...5000N·m

Vertical Calibration System using precision geared torque generator with reference torque transducers.

- Product: In-Line Rotating Torque Sensors, Torque Flanges, Reaction Torque Sensors.
 Throughput time: 5-10 days
 Accreditation: ISO/IEC 17025 / SCS 0139
 Range: 1 ... 50kN·m
 Best Uncertainty: ± 0.04% (min. 0.05 N·m), range 1 ... 2 kN·m
 ± 0.04% (0.3N·m), range 5 ... 10kN·m
 ± 0.09% (4 N·m), range 20 ... 50kN·m

Calibration for Full System based on a test bench for dynamometers and complete measurement chain.

- Product: WB/PB Dynamometer, measurement chain WB/PB + DES + TSC + DSP 7000.
 Throughput time: on request
 Accreditation: ISO/IEC 17025 / SCS 0139
 Range: 1.5 ... 200 N·m
 Best Uncertainty: ± 0.9% (min. 0.02N·m), range 1.5... 10N·m
 ± 0.9% (min 0.2N·m), range 20 ... 200N·m



Torque Calibration Laboratory located at Magtrol SA (Switzerland)

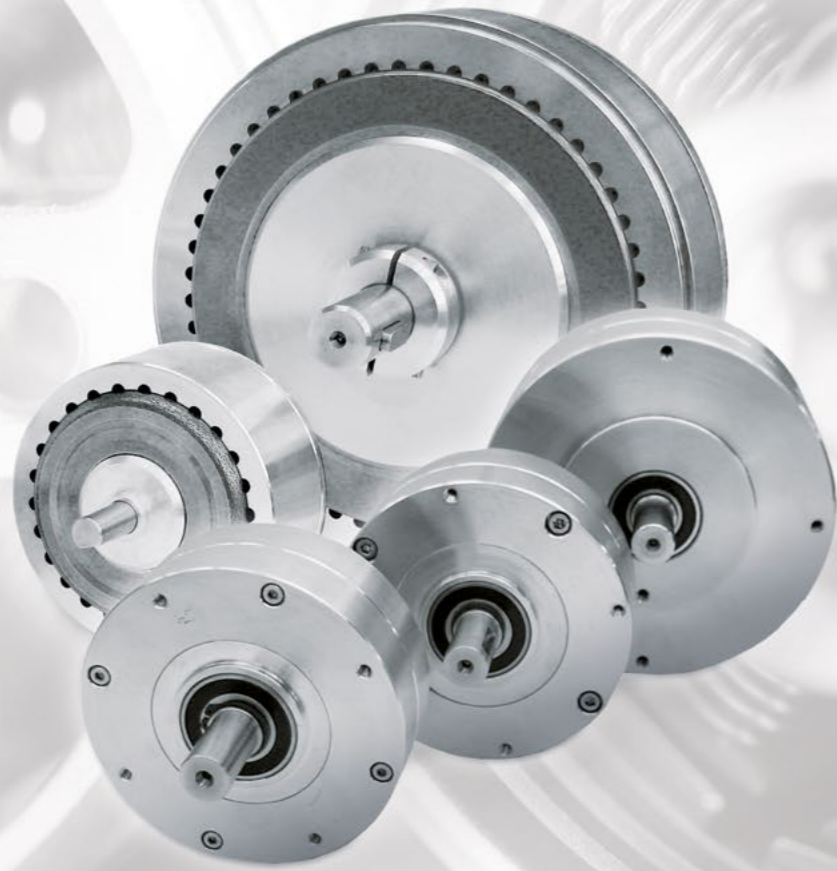

Industrial Brakes

Since its inception, Magtrol has developed a wide range of industrial brakes based on Hysteresis and Magnetic Powder technologies. Unlike many other torque control devices, our devices provide absolutely smooth, infinitely controllable torque loads, independent of speed.

This provides such advantages as: longer expected life, superior torque repeatability, life cycle cost advantages, broad speed range, excellent environmental stability, and superior operational smoothness.

As a result, Magtrol's industrial brakes are ideal for demanding applications such as: torque measurement systems, precise tension control (winding, pay-off, packaging, EDM wire cutting), load simulation motor testing, etc..

HOW TO CHOOSE THE PERFECT INDUSTRIAL BRAKE
To properly size a brake, dynamometer or clutch, the operating parameters of Torque [N·m], Speed [rpm], and Kinetic Power [W] will have to be determined.

The first step is to calculate the operating requirements of the system and then derive the three values listed above. Once calculated, these parameters can be used to select the proper size brake from the technical data provided in our product datasheets.

Please contact our technical department. Our specialized engineers will be happy to assist you.

MODEL	RATED TORQUE						Max. SPEED	Max. POWER	COOLING METHOD	Hysteresis	Powder
	0.01N·m	0.1N·m	1N·m	10N·m	100N·m	1000N·m					
HB Series	0.02 N·m		26 N·m				≤20000 rpm	≤2400 W	Convection	X	
AHB Series	0.3 N·m		24 N·m				≤25000 rpm	≤5300 W	Compressed Air	X	
BHB Series			3...24 N·m				≤20000 rpm	≤7000 W	Blower	X	
CHB Series			1...24.7 N·m				≤12000 rpm	≤2400 W	Convection	X	
TPB Series			6 N·m		600 N·m		≤1800 rpm	≤2100 W	Convection or Compressed Air		X

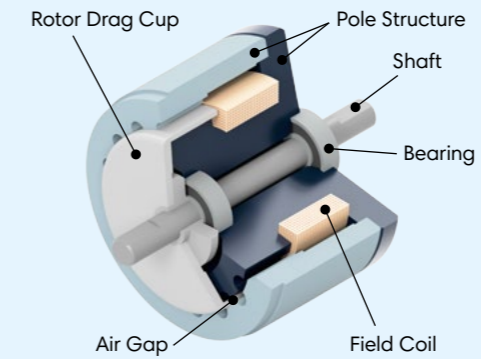

HYSTERESIS BRAKES

The hysteresis effect in magnetism is applied to torque control by the use of two basic components (a reticulated pole structure and a specialty steel rotor/shaft assembly) fastened together but not in physical contact. Until the field coil is energized, the drag cup can spin freely on the ball bearings. When a magnetizing force from either a field coil or magnet is applied to the pole structure, the air gap becomes a flux field. The rotor is magnetically restrained, providing a braking action between the pole structure and rotor.

Because torque is produced strictly through a magnetic air gap, without the use of friction or shear forces, Magtrol Hysteresis Brakes provide absolutely smooth, infinitely controllable torque loads, independent of speed, and they operate quietly without any physical contact of interactive members. As a result, with the exception of shaft bearings, no wear components exist.

APPLICATION FIELD FOR MAGTROL BRAKES

Below are some typical applications for Magtrol's industrial brakes.

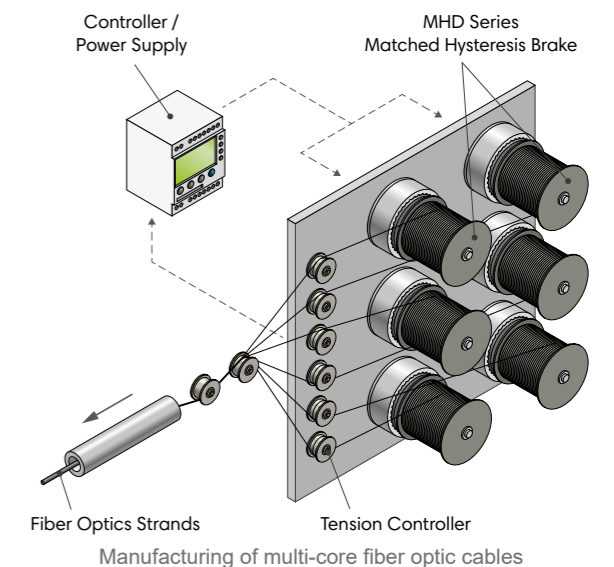
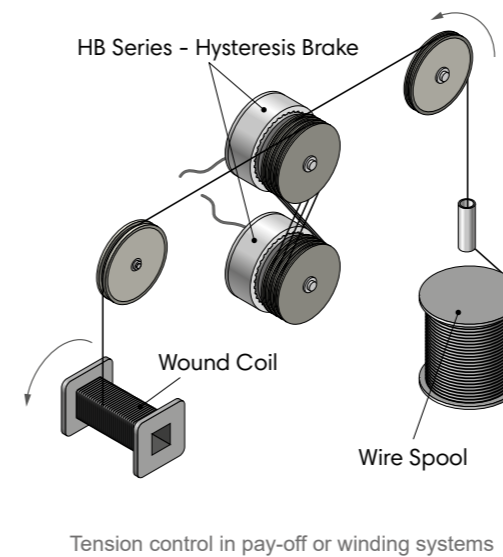
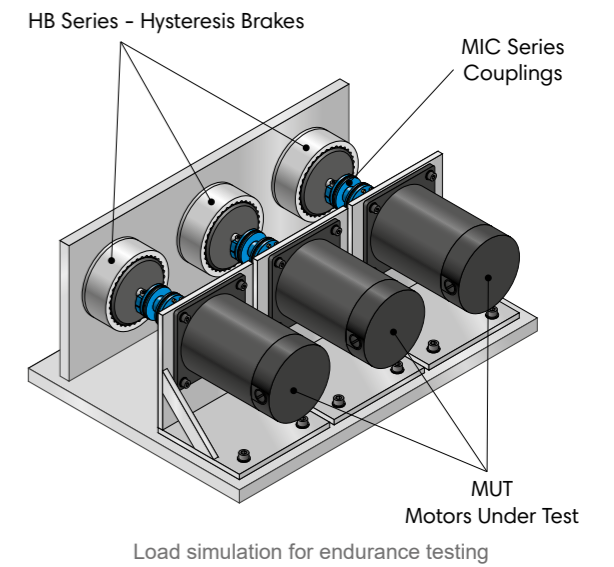
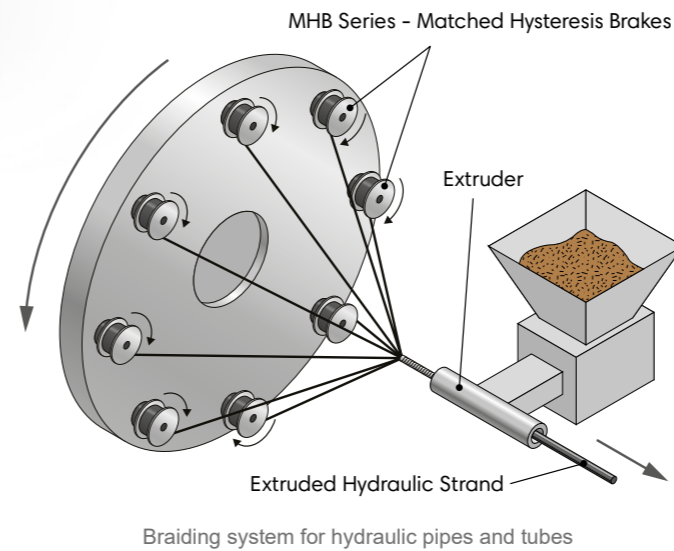

HB/MHB SERIES Hysteresis Brakes

Hysteresis and Matched Hysteresis Brakes

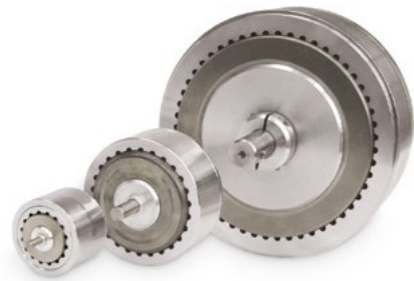

In tension control applications that have multiple webs or multiple strands, it is very desirable to match the tension of each web or strand. This is most commonly attained by using a closed-loop servo control system which controls current to a braking device through the use of dancer arms, follower arms and in-line tension transducers. The problem with such systems is that each web or strand must be individually controlled, increasing the cost and complicating the system with multiple sensors and power supplies.

To solve this problem, Magtrol developed a system to assure that every brake of a given model designation will be matched - at a predetermined torque and current point - to other brakes of the same model designation. Regardless of material and manufacturing tolerances, each brake is matched at the selected match point to within a tolerance of $\pm 1\%$. The maximum deviation in torque from brake to brake at any point along their torque/ current curve (from 0 torque up to the selected matched torque point) is less than $\pm 4\%$ of the selected matched torque value.

With this level of matching, a system with multiple tension rollers would provide tension consistency within $\pm 1\%$ if set at the matched point with all brakes receiving the same current. The matched point can be any value between 50% and 100% of rated torque, which allows the brakes to be optimized for specific applications. Unless otherwise specified, all brakes are matched at 100 rpm.

- Ideal for low-torque/high-speed applications with exceptional power ratings
- Torque: 0.02... 26 N·m
- Speed: up to 20 000 rpm
- Power: up to 2 400 W
- Available in Metric / English dimensions
- Torque independent of speed
- Long, maintenance-free life
- Magtrol hysteresis braking technology provides precise torque control independent of shaft speed
- EMC conforms to European standards

HYSTERESIS CURVES

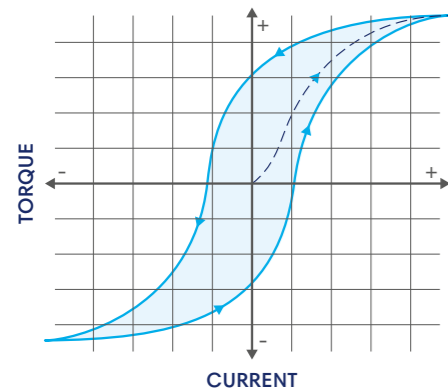

The hysteresis cycle is usually represented as a two-dimensional curve. Hysteresis occurs when the upward curve of the cycle does not overlap with the downward curve. The hysteresis cycle is always symmetrical.

At Magtrol, hysteresis is an essential feature of our products, as many of our products utilize this concept. In order to measure, represent and compare our products, we use torque vs. current curves as represented above.

This Hysteresis Curve is such an important characteristic of our products that Magtrol has chosen to use this representation in our corporate identity.

BRAKE RATINGS

MODEL	MIN. TORQUE AT RATED CURRENT N·m	RATED CURRENT mA	VOLTAGE ^{a)} VDC	MAX. SPEED rpm	KINETIC POWER ^{b)}	
					5 min. W	Continuous W
HB/MHB 3M	0.02	145	25.0		20	5
HB/MHB 10M	0.07	133	24.0	20 000	45	12
HB/MHB 20M	0.14	217	26.0		50	12
HB/MHB 50M	0.35	253	24.0	15 000	90	23
HB/MHB 140M	1.00	253	24.0	12 000	300	75
HB/MHB 250M	1.75	270	26.0	10 000	450	110
HB/MHB 450M	3.20	442	22.1	8 000	670	160
HB/MHB 750M	5.00	383	23.0	7 000	1 000	200
HB/MHB 1750M	13.00 ^{c)}	600	31.2	6 000	1 200	350
HB 3500M	26.00 ^{d)}	1 200	31.2	6 000	2 400	600

- a) Other coil voltages are available.
- b) Kinetic power ratings are maximum values based on limiting coil and/or bearing temperature to approximately 100°C, and should not be exceeded. Actual values in service may vary $\pm 50\%$ depending on mounting, ventilation, ambient temperature, etc.
- c) 13 N·m is attainable @ approx. 600 mA. This value may decrease to 12.36 N·m if the brake is powered by any power supply or controller limited to 500 mA.
- d) 26 N·m is attainable @ approx. 1200 mA. This value may decrease to 24.72 N·m if the brake is powered by any power supply or controller limited to 1000 mA.

AHB SERIES Compressed-Air-Cooled Brakes

Hysteresis Brake mounted on a base plate and cooled by means of compressed air



When torque control/torque measurement must be performed at the highest possible power, Magtrol AHB Series Hysteresis Brakes are ideal. Passages running through the brakes enables compressed air cooling, providing excellent heat dissipation. This design allows for continuous power ratings up to 3 000 W (5 300 W intermittent). Use of pre-loaded bearings in the AHB Series Hysteresis Brakes allows operation at speeds of up to 35 000 rpm for extended durations.

AHB Brakes are conveniently base mounted. Base mounting, with integral barrier type terminal strip, provides easy mounting and wiring.

- Ideal for low-torque/high-speed applications with exceptional power ratings.
- Torque: 0.3... 24 N·m
- Speed: up to 35 000 rpm
- Power: up to 5 300 W
- Compressed-Air Cooling offers excellent heat dissipation.
- Allowable input air pressure of up 95 PSI eliminates the need for a regulator.
- EMC susceptibility conforms to European standards
- Magtrol hysteresis braking technology provides precise torque control independent of shaft speed.
- Designed for use with Magtrol's PT Series T-slot Base Plate mounting system.
- A variety of accessories and system options to choose from to create a simple and cost-effective test system.

BRAKE RATINGS

MODEL	MIN. TORQUE AT RATED CURRENT N·m	RATED CURRENT mA	MAX. SPEED rpm	KINETIC POWER ^{b)}			
				WITH AIR		WITHOUT AIR	
				5 min. W	Continuous W	5 min. W	Continuous W
AHB 0.3 ^{a)}	0.3	300	25 000	500	500	90	25
AHB 0.75 ^{a)}	0.65	400	35 000	1 200	1 200	250	55
AHB 1	1.0	400	25 000	1 200	1 200	250	55
AHB 1.5	1.5	400	25 000	1 300	1 300	450	70
AHB 3	3.0	750	20 000	1 800	1 800	800	160
AHB 3.3	3.3	800	25 000	2 000	1 400	800	140
AHB 5	5.0	380	15 000	2 500	1 000	1 300	120
AHB 6	6.0	1 500	20 000	3 000	3 000	1 400	225
AHB 12	12.0	1 200	12 000	2 800	1 800	2 200	250
AHB 24	24.0	2 400	12 000	5 300	3 000	4 000	450

a) Designed with angular contact bearings, the AHB-0.3 & AHB-0.75 were designed for severe application. These applications include, but are not limited to, high vibration or high radial and/or axial loading.

b) Kinetic power ratings are maximum values based on limiting coil and/or bearing temperature to approximately 100 °C, and should not be exceeded. Actual values in service may vary $\pm 50\%$ depending on mounting, ventilation, ambient temperature, etc.

APPLICATIONS

Magtrol's AHB Series Compressed-air-cooled Hysteresis Brakes can function in either torque measurement or torque control applications.

When mounted to the PT 25 Series T-slot Base Plate, a cost-effective, basic motor test rig can be easily configured. For this purpose, Magtrol offers several accessories and system options to choose from.

The simplest test bench may include one or two AHB Brakes and an AMF Adjustable Motor Fixture mounted onto a PT Base Plate. Adding a TS Series or TM Series In-Line Torque Transducer, couplings, MODEL 341 1 Torque Display or DSP 7000 Controller greatly expands the system's motor testing capabilities.

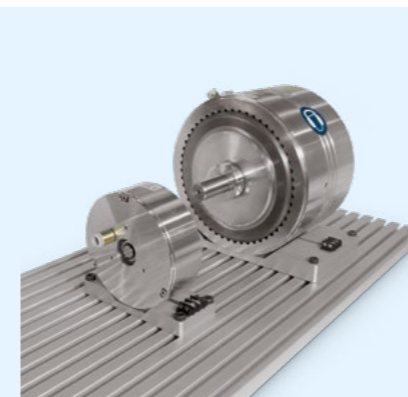

BHB SERIES Blower-Cooled Brakes

Hysteresis Brake mounted on a base plate and cooled by means of a blower

When torque control/torque measurement must be performed at the highest possible power, Magtrol BHB Series Hysteresis Brakes are ideal. This design allows for continuous power ratings up to 6000 watts (7000 watts intermittent).



Use of pre-loaded bearings in the BHB Series Hysteresis Brakes allows operation at speeds of up to 20000 rpm for extended durations. BHB Brakes are conveniently base mounted. Base mounting, with integral barrier type terminal strip, provides easy mounting and wiring.

- Ideal for low-torque/high-speed applications with exceptional power ratings
- Torque: 3 N·m ... 24 N·m
- Speed: up to 20000 rpm
- Power: up to 7000 W
- Included blowers eliminate the need for additional air supply equipment
- Includes air deflectors to guide exhaust air away from the motor under test
- Magtrol hysteresis braking technology provides precise torque control independent of shaft speed
- EMC susceptibility conforms to European standards
- Designed for use with Magtrol's PT Series T-slot Base Plate mounting system
- A variety of accessories and system options to choose from to create a simple and cost-effective test system

BRAKE RATINGS

MODEL	MIN. TORQUE AT RATED CURRENT N·m	RATED CURRENT mA	MAX. SPEED rpm	KINETIC POWER ^{a)}			
				WITH AIR		WITHOUT AIR	
				5 min. W	Continuous W	5 min. W	Continuous W
BHB 3	3	750	20000	1500	935	800	160
BHB 6	6	1500		3400	3000	1000	225
BHB 12	12	1200	12000	3500	3000	2200	250
BHB 24	24	2400		7000	6000	4000	450

a) Kinetic power ratings are maximum values based on limiting coil and/or bearing temperature to approximately 100 °C, and should not be exceeded. Actual values in service may vary ±50% depending on mounting, ventilation, ambient temperature, etc.

BL SERIES Blower Kit

Large autonomous air cooler for dynamometers and brakes



To improve cooling power, BHB Series brakes are delivered with a blower kit.

The blower is a turbine which provides concentrated air flow to cool down the brake to which it is connected. For better cooling efficiency, the tubing between blower and brake should be as short as possible. The blower generates a noise equivalent to a vacuum cleaner.

Depending on the required cooling capacity, 2 blower models are available:

- **BL 01** (for BHB 3, BHB 6, BHB 12)
- **BL 02** (for BHB 24)

CHB SERIES Base Mounted Brakes

Hysteresis Brake mounted on a base plate and cooled by convection



Magtrol pioneered the technology of applying the principles of hysteresis to meet the critical needs for reliable, smooth and adjustable torque control. Magtrol's Hysteresis Brakes produce torque strictly through a magnetic air gap without the use of magnetic particles or friction components.

This method of braking provides far superior operating characteristics (smoother torque, longer life, superior repeatability, high degree of controllability, and less maintenance and down time) which make them the preferred choice for precise tension control during the processing of nearly any material, web or strand.

- Ideal for low-torque/high-speed applications with exceptional power ratings
- Torque: 1 ... 24.72 N·m
- Speed: up to 12000 rpm
- Power: up to 2400 W
- Torque independent of speed
- Long, maintenance-free life
- Magtrol hysteresis braking technology provides precise torque control independent of shaft speed
- Designed for use with Magtrol's PT Series T-slot Base Plate mounting system (sold separately)
- EMC conforms to European standards
- A variety of accessories and system options to choose from to create a simple and cost-effective test system

BRAKE RATINGS

MODEL	MIN. TORQUE AT RATED CURRENT N·m	RATED CURRENT mA	VOLTAGE ^{a)} VDC	MAX. SPEED rpm	KINETIC POWER ^{b)}	
					5 min. W	Continuous W
					CHB 1	1.00
CHB 1.5	1.75	270	26.0	10000	450	110
CHB 3	3.20	442	22.1	8000	370	160
CHB 5	5.00	383	23.0	7000	1000	200
CHB 6	5.90	884	24.0	6000	1340	300
CHB 12	12.36	500	26.0		1200	350
CHB 24	24.72	1000	26.0	2000	600	

a) Other coil voltages are available.

b) Kinetic power ratings are maximum values based on limiting coil and/or bearing temperature to approximately 100 °C, and should not be exceeded. Actual values in service may vary ±50% depending on mounting, ventilation, ambient temperature, etc.

USING CURVES TO SELECT THE OPTIMAL BRAKE

In the field of brakes and dynamometers, curves are a widely used tool to present the capabilities of products and to compare them in order to select the suitable model.

Curve diagrams have the advantage of visually presenting the scope of the product and its performance. We use this medium extensively to explain the capabilities of our products at different values, to present the different ranges of a product line and to compare different models. The curves can be presented in a relative or logarithmic model.

For more information, please contact our sales support team or visit our website: www.magtrol.com

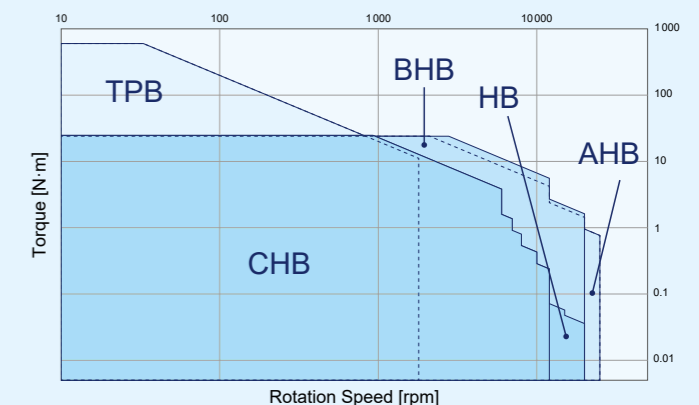

TPB SERIES Torque Powder Brake

Magnetic Powder Brake



The Torque Powder Brakes (TPB Series) are ideal for applications operating in the low speed range or middle to-high torque range. These magnetic powder brakes provide full torque at zero speed and are convection or air cooled, allowing power ratings up to 900W (2 100W with air cooling).

- Torque: 6...600N·m
- Power: up to 900W (2 100W with air cooling)
- Speed: up to 1 800rpm
- Rated torque available from 0rpm
- Stable braking torque
- Low moment of inertia
- Low residual torque
- Operation in both rotational directions
- Delivered with foot mount
- For horizontal use only

BRAKE RATINGS

MODEL	RATED TORQUE	RATED CURRENT	VOLTAGE	MAX. SPEED	KINETIC POWER	
	N·m	A			WITH AIR	WITHOUT AIR
TPB 006	6	0.81	24	1800	N/A	50
TPB 012	12	0.94			250	145
TPB 025	25	1.24			380	230
TPB 050	50	2.15			700	360
TPB 100	100	2.40			1 100	600
TPB 200	200	2.70			1900	840
TPB 400	400	3.50			2 100	900
TPB 600	600	4.30				

CUSTOMIZED TEST BENCH - CYCLISTS PERFORMANCES ANALYSIS

The **FAST_SPOR'IN** (Sport & Wellness) program of the **University of Aix-Marseille** (France), supported by the **Carnot STAR Institute** of Marseille, has commissioned Magtrol to develop a custom test bench for analyzing the biomechanical performance of cycling athletes.

After studying the project, Magtrol's CMTS (Custom Motor Test System) department proposed a simple solution that permits the use of a standard bike. The only handling required is to replace the rear wheel with a drive system that allows the bike to be coupled to a test deck that includes Magtrol's standardized components.

Mainly built around a TPB Series Powder Brake and a TM Series Torque Sensor, the system allows to regulate the effort provided by the rider by producing a load of up to 400N·m. The mechanical design was intended to be very rigid in order to ensure the greatest possible stability for the system and the user.

This test bench is currently used on the **TechnoSport Platform** (Faculty of Sport Sciences in Marseille) which works closely with top athletes to study and improve their biomechanical performance and physiological impacts.



Already present with its sensors and test benches in the market motor manufacturing and training systems for electrical bicycles, Magtrol completes its contribution in the fields of cycling and mobility.

Power Supplies

CURRENT REGULATED POWER SUPPLY

Due to their current regulation, these power supplies guarantee a perfect stability of the torque released by the brake during the test. The two models below have been specially developed by Magtrol to allow the regulation of hysteresis brakes. The MODEL 5212 is a portable, stand-alone power supply, perfect for use in production and laboratory environments or for integration into a machine. The MODEL 5251 is a power supply in open frame version. It is ideal to be mounted in a free standing box or other custom needs.

MODEL 5212 Current Regulated Supply



MODEL 5212 is a 0... 1 A current-regulated, 0... 35VDC power supply and display designed for use with hysteresis brakes and clutches. It features a 10-turn current adjustment potentiometer and 3 selectable current ranges: 200... 1000 mA.

A built in panel meter displays the value of output current.

The MODEL 5212 is designed as a closed-loop power supply to provide smooth application of current throughout an entire range up to a maximum set point. By utilizing regulated current, fluctuations in brake torque caused by temperature changes within the brake coil are eliminated. Braking current can be controlled manually or by an external 0... 5VDC input signal.

STANDARD POWER SUPPLY

Although their functionality is less sophisticated than that of the current-regulated power supply, the standard power supplies allow precise control of the various Magtrol brake models.

ZUP Power Supply



The ZUP is a 0... 36VDC benchtop power supply which provides current regulation of the braking torque via a turning knob. This powerful and versatile power supply can power all Magtrol brakes, with an output current up to 6 A. The ZUP power supply is required to power brakes with

high kinetic power, which require supply currents greater than 3 A (e.g. TPB 400, TPB 600, etc.). This unit can also be controlled with an analog input signal 0... 4 V.

MODEL 5251 Current Regulated Supply



MODEL 5251 is an open frame, 0... 1 A current regulated power supply for use with Magtrol hysteresis brakes and clutches. It has a high input impedance that allows for a variety of sensors and transducers to be used. It features a

selectable 0... 5VDC monitor out that allows connection to a PLC, voltmeter, display or other monitoring device. This allows the user to monitor the current applied directly to the brake or clutch, if desired. With regulated current, torque drift caused by temperature changes within the brake coil is eliminated. Braking control is enabled by using either a 10-turn potentiometer or by an external 0... 5VDC control signal.

BPM SERIES Brake Power Module



The BPM Series - Brake Power Module is used to supply and control the current (up to 3 A) of Magtrol Hysteresis Brakes and Clutches. This compact component (DIN rail mount) is recommended for easily controlling a wide range of brakes

and clutches. The analog input of the Brake Power Module is designed for 0... 10VDC signals. At the maximum set value of 10VDC, the output current is adjustable 0... 100%.

POWER SUPPLIES COMPATIBILITY

BRAKE MODELS	MODEL 5212	MODEL 5251	BPM 101	BPM 103	ZUP
HB Series	X	X	X	--	--
HB 3500M	--	--	--	X	X
AHB 1, AHB 1.5, AHB 3, AHB 3.3 & AHB 5	X	X	X	--	--
AHB 6, AHB 12 & AHB 24	--	--	--	X	X
BHB 3	X	X	X	--	--
BHB 6, BHB 12, BHB 24	--	--	--	X	X
CHB Series	X	X	X	--	--
TPB 06, TPB 12	X	X	X	--	--
TPB 25, TPB 50, TPB 100, TPB 200	--	--	--	X	X
TPB 400, TPB 600	--	--	--	--	X



DYNAMOMETER OPTIONS

Magtrol's Dynamometers are available in many different versions to meet the unique needs of our customers. In addition to the versions below, our team of specialized engineers are available to customize a system designed to meet a multitude of requirements, whether it's for series testing, extreme specifications or special climatic environments.

HIGH SPEED (HS)

For testing high-speed motors, Magtrol offers the WB Series Eddy-Current Dynamometer with speed ranges up to 65 000 rpm.

For small or miniature motors, Magtrol models WB 23 & WB 27 Eddy-Current Dynamometers, the Microdyne and the MSD System are available for speeds up to 100 000 rpm.

INDUSTRIAL VERSION (IS)

WB & PB Series Dynamometers are also available in an industrial version, which includes the base plate, but does not provide torque nor speed measurement.

MECHANICAL ROTOR BLOCKING DEVICE (MB)

As Eddy Current principle is proportional to speed and do not provide braking torque at 0 rpm, a mechanical rotor blocking device, which allows locked rotor testing, is available as an option.

OPTICAL SPEED SENSOR

Each WB, PB, HD & ED Series Dynamometer includes an optical speed sensor min. 30 PPR (Pulse Per Revolution). For low speed motors (e.g. gear motors) Magtrol offers additional encoder options (600/6000 PPR) to increase the resolution of the speed signal.

VERTICAL MOUNTING (V)

Vertical Mounting is available on Eddy-Current WB Dynamometers. The vertical version has an adapted bearing fitting and its maximum speed is limited.

ENGINE DYNAMOMETER (ED SERIES)

Engine Dynamometers have been specially designed to address the severe, high vibration conditions inherent in internal combustion engine testing. Additionally, Magtrol also provide special version of the WB Eddy-Current Dynamometer based on Hysteresis technology adapted to engine testing applications.

Dynamometers

MAGTROL offers 3 types of dynamometer brakes to absorb load: Hysteresis (HD Series), Eddy-Current (WB Series) and Magnetic Powder (PB Series). Each type of Dynamometer has advantages and limitations and choosing the correct one will

depend largely on the type of testing to be performed. With over 50 standard models to choose from, Magtrol Sales professionals are readily available to assist in selecting the proper Dynamometer to meet your testing needs.

MODEL	RATED TORQUE							Max. SPEED	Max. POWER	COOLING METHOD
	0.001 N-m	0.01 N-m	0.1 N-m	1 N-m	10 N-m	100 N-m	1000 N-m			
HD Series		0.018 N-m			56.5 N-m			≤ 50 000 rpm	≤ 14 kW	Convection, Compressed Air, Blower
WB Series			0.3 N-m			560 N-m		≤ 65 000 rpm	≤ 140 kW	Water
PB Series				0.6 N-m		1 200 N-m		≤ 10 000 rpm	≤ 48 kW	Water
TANDEM Series					5 N-m	1 200 N-m		≤ 25 000 rpm	≤ 140 kW	Water
Micro Dyne	0.002...0.004 N-m							≤ 100 000 rpm	≤ 4 W	Convection
MSD System		0.02 N-m						≥ 400 000 rpm	≤ 40 W	Convection
WB 23/27			0.08...0.15 N-m					≤ 100 000 rpm	≤ 1 000 W	Convection

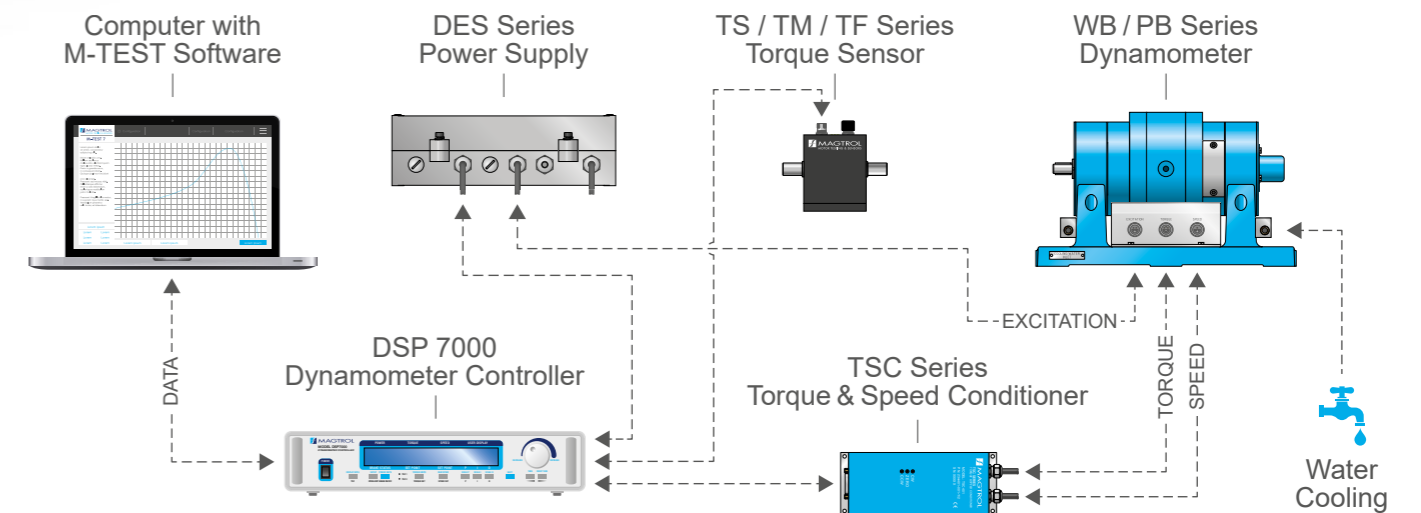

WHAT IS THE DIFFERENCE BETWEEN HYSTERESIS, EDDY-CURRENT AND POWDER DYNAMOMETERS?

The difference between Eddy-current, magnetic powder and hysteresis brakes is the design of the brake itself. All have a rotor and stator of which the design is adapted to its technology. A coil (in the stator) produces a magnetic field when supplied by an excitation current.

Hysteresis Dynamometers – Have a stator in 2 parts with a rotor in the form of a cup rotating in the magnetic field, between 2 stator parts. Hysteresis brakes provide braking power from 0 rpm to middle range speed (up to 10 000 to 20 000 rpm, depending on size).

Powder Dynamometers – Use a metallic powder between the rotor and stator of the brake. When excitation current is applied, the powder sticks on the rotor (according to the magnetic field lines) and brakes by friction. Powder brakes have a strong (nominal) braking torque at 0 rpm but are limited in speed (up to 1 000 to 3 000 rpm depending on the size of the dynamometer).

Eddy-current Dynamometers – Have a splined rotor. The splined part of the rotor in the magnetic field produces the braking effect. Eddy-current dynamometers apply braking power proportional to the speed (no braking power at 0 rpm) and are specially adapted for middle to very high speed applications (up to 50 000 rpm or even 100 000 rpm).

Both Hysteresis and Eddy-current dynamometers can work in a vertical application, but this has to be mentioned early (at RFQ), since vertical versions are special designs. Powder brakes are not adapted to vertical use. Choose the right technology depending on your application, determining which torque in which speed range you would like to test.

HD SERIES Hysteresis Brake Dynamometers

Hysteresis Dynamometers for testing motors in the low to medium power range



Hysteresis Brake Dynamometers (HD Series) are versatile and ideal for testing in the low to medium power range (maximum 14kW intermittent duty). With a Hysteresis Braking system, the Dynamometers do not require speed to create torque, and therefore can provide a full motor ramp from free-run to locked rotor. Brake cooling is provided by convection (no external source), by compressed air or by dedicated blower, depending on the model. All Magtrol Hysteresis Dynamometers have accuracy ratings of ±0.25% (full scale) depending on size and system configuration.

To better integrate dynamometers into systems, Magtrol offers both long and short base plates. The shorter base plate facilitates easier motor mounting when used with T-slot tables and Magtrol Adjustable Motor Fixtures, whereas the long base plates are better suited for table top testing.

- 16 Standard Models with Maximum Torque 0.018...56.5N·m
- 14 High Speed Models Available
- Hysteresis Braking System: provides precise torque loading independent of shaft speed
- Motor Testing: from no load to locked rotor
- Accuracy: ±0.25% (full scale)
- Standard Torque Units SI (English & Metric available upon request)
- Air Flow Sensor: For protection against overheating and operator error
- Base Plates: available in long or short versions
- Custom Dynamometers: for special torque and speed requirements
- Easy Calibration

ED ENGINE DYNAMOMETER

Magtrol's ED 715 and ED 815 Engine Dynamometers have been designed to address the severe, high vibration conditions inherent in internal combustion engine testing.

These Dynamometers offer superior performance on the production line, at incoming inspection or in the R&D lab and are ideally suited for emissions testing as set forth in CARB and EPA Clean Air Regulations.

Magtrol also offers specially designed WB 65 and WB 115 Eddy Current dynamometers specifically adapted for higher power Engine testing capacity.

5 MIN. VS CONTINUOUS ?

Operating at the continuous power rating for periods of up to 4 hours is acceptable. However, operating for extended periods at high temperatures will result in premature component and bearing failure. Limiting the length of the cycle and the component temperatures will guard against premature failure.

Where continuous duty is desired for longer time intervals, component temperatures should be maintained less than 100°C; monitoring the outside brake surface temperature is a sufficient reference

DYNAMOMETER RATINGS

MODELS	MAXIMUM TORQUE RANGE N·m	MAX. POWER RATINGS		MAXIMUM SPEED		COOLING METHOD				
		5 min. W	Continuous W	Standard rpm	High Speed rpm	Convection	Compressed Air ^{a)}	Blower ^{b)}		
MICRO DYNE	0.002/0.004	4	4	100 000	N/A	x				
HD 106	0.018	35	7	30 000	50 000	x				
HD 100	0.08	75	20	25 000	40 000	x				
HD 400	0.28	200	55			x				
HD 500	0.85	400	80			x				
HD 510		750	375				x			
HD 505	1.7	800	160			x				
HD 515		1500	900				x			
HD 700		700	150							
HD 710	3.1	1500	935			35 000	40 000		x	
HD 705	6.2	1400	300					x		
HD 715		3400	3000							x
HD 800	14.0	2800	1800	12 000	N/A	x				
HD 810		3500	3000		15 000		x			
HD 805		5300	2250		N/A	x				
HD 815	28.0	7000	6000	8 000	15 000		x			
HD 825		14 000	12 000		10 000		x			

a) Requires air cooling provided by user. Regulator and filter package is provided as standard

b) Blower is included

Micro Dyne Motor Testing System

Complete motor test system specifically designed for small motors



Magtrol's Micro Dyne, capable of measuring extremely low torques (2.0 mN·m with a resolution of 0.0004 mN·m), is designed exclusively for testing miniature and micro motors (low-torque).

For the utmost convenience, the Micro Dyne is packaged as a **complete motor testing system**. Everything that is needed to accurately and efficiently test miniature motors and micro motors is included with the purchase of a Magtrol Micro Dyne. The only component that needs to be supplied by the customer is a laptop or desktop personal computer and motor power supply.

Motor Characteristics that may be Measured/Calculated: Torque, Speed, Amps, Volts, Horsepower, Efficiency, Input Watts & Output Watts

- Designed specifically for miniature and micro motors
 - Torque: Easily convertible 2... 4 mN·m
 - Speed: up to 100 000 rpm
 - Power: 4 W
 - Low inertia
 - Sold as a complete, out-of-the-box motor testing system.
- Components include:
- Hysteresis Dynamometer: provides precise torque loading independent of shaft speed
 - Motor Fixture: accommodates motors ø5... 30 mm
 - Dedicated Electronics: all-in-one dynamometer controller, DC wattmeter, power relay and USB interface
 - Include Magtrol's M-TEST Software
 - Easy-to-use calibration software
 - All necessary connection cables
 - Calibration weights: 5g and 10g

BL SERIES Blower Kit

Large autonomous air cooler for dynamometers and brakes



To improve cooling power some HD Series Dynamometers are delivered with a blower kit.

The blower is a turbine which provides concentrated air flow to cool down the dynamometer to which it is connected. For better cooling efficiency, the tubing between blower and dynamometer should be as short as possible.

The Blower generates a noise equivalent to a vacuum cleaner.

Depending on the required cooling capacity, 2 blower models are available:

- **BL 01** (for HD 710, HD 715, HD 810)
- **BL 02** (for HD-815, HD-825)

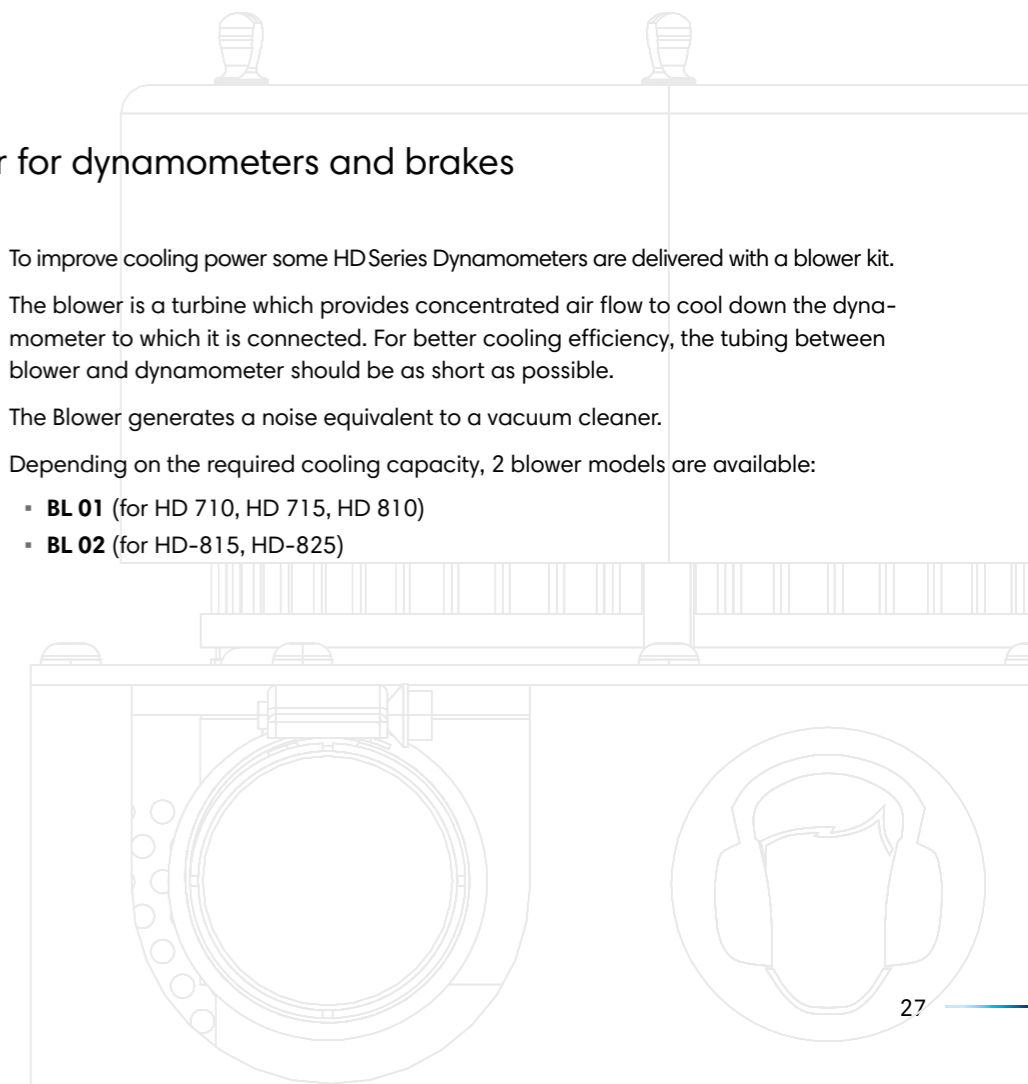

WB SERIES Eddy-Current Dynamometers

Industrial and Highly Resistant Eddy-Current Dynamometer



Eddy-Current Brake Dynamometers (WB Series) are ideal for applications requiring high speeds and also when operating in the middle to high power range. Eddy-Current Brakes provide increasing torque as the speed increases, reaching peak torque at rated speed. The dynamometers have low inertia as a result of small rotor diameter. Brake cooling is provided by a water circulation system, which passes inside the stator to dissipate heat generated by the braking, providing high continuous power ratings (max. 140 kW). WB Series Dynamometers integrate a torque measuring system with an accuracy ratings of $\pm 0.3\% \dots \pm 0.5\%$ full scale, depending on size and system configuration.

- 13 Models Standard with Maximum Torque: 0.3...560 N·m
- Braking Power: 0.5...140 kW
- Stable Braking Torque, without Shock
- Low Moment of Inertia
- Low Residual Torque
- Operating Direction CW / CCW
- Braking Torque Measurement Integrated
- High Rotational Speed
- Integrated Optical Speed Sensor
- Special designs available upon request

COMBUSTION ENGINE TESTING

Internal combustion engines generate high vibration and severe testing conditions.

In addition to the Magtrol ED 715 and ED 815 Engine Dynamometers, Magtrol also offers specially designed WB 65 and WB 115 Eddy Current dynamometers specifically adapted for higher power Engine testing capacity to address the severe, high vibration conditions inherent in internal combustion engine testing.

These Dynamometers offer superior performance on the production line, at incoming inspection or in the R&D lab and are ideally suited for emissions testing as set forth in CARB and EPA Clean Air Regulations.

DYNAMOMETER RATINGS						
MODEL	RATED TORQUE	RATED POWER	RATED SPEED	MAX. SPEED		COOLING SYSTEM
	N·m	kW	rpm	STANDARD rpm	HIGH-SPEED (HS version) rpm	
2WB 2.7	0.3	0.5	15915	50 000	N/A	Water
3WB 2.7	0.45	0.75				
4WB 2.7	0.6	1.0				
1WB 43	1.5	1.5	9550	50 000	65 000	Water
2WB 43	3.0	3.0				
1WB 65	10	6	5730	30 000	50 000	Water
2WB 65	20	12				
1WB 115	50	15	2865	18 000	22 000	Water
2WB 115	100	30				
1WB 15	140	35	2390	7 500	N/A	Water
2WB 15	280	70				
3WB 15	420	105				
4WB 15	560	140				

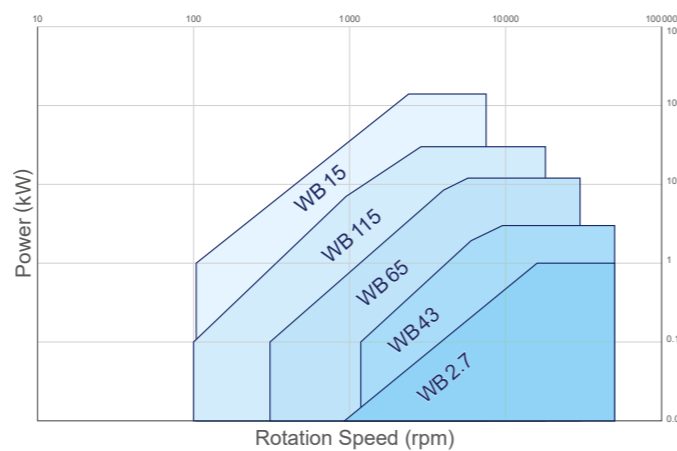
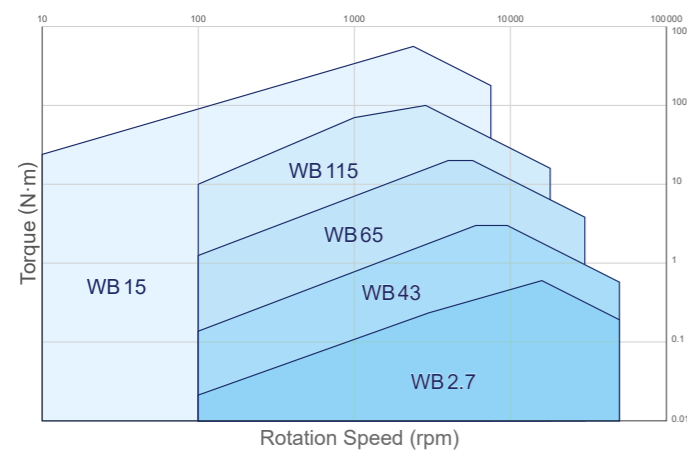

WB 23/27 High-Speed Dynamometers

High-Speed Eddy-Current Dynamometers

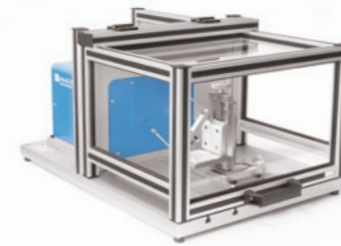

Magtrol's WB 23 and WB 27 Eddy-Current Dynamometers are designed for very-high-speed motors and dental or surgical tool testing applications. By providing a braking torque that is proportional to the rotational speed, rated torque is reached at the rated speed.

The Dynamometers feature a low level of inertia, due to small rotor dimensions, and brake cooling is provided by air flow inside the dynamometer housing.

A PT temperature sensor continuously monitors the brake temperature and alarms the DSP 7000 Controller to stop the brake excitation current in order to protect the dynamometer from overheating.

Torque is measured by a reaction torque transducer placed on the stator. The dynamometer has a torque measuring accuracy rating of $\pm 0.2\%$ full scale. The speed is measured by an optical sensor and a 2 PPR (Pulses Per Revolution) encoder. This sensor measures speeds between 10 000 rpm and 100 000 rpm with a full scale accuracy of $\pm 0.06\%$ (using a DSP 7000).

- Torque: 80 mN·m / 150 mN·m
- Speed: up to 100 000 rpm
- Power: 250 W continuous; up to 500 W (WB 23) or 1 kW (WB 27) intermittent
- Low inertia
- Very low residual torque
- Stable and smooth braking torque
- Measuring system with air-bearing
- Data acquisition via DSP 7000 Controller and M-TEST Software
- Built-in electronics with Torque & Speed measurement

DYNAMOMETER RATINGS						
MODEL	RATED TORQUE	DURATION AT RATED POWER	RATED POWER	RATED SPEED	MAXIMUM SPEED	COOLING SYSTEM
	mN·m	s	W	rpm	rpm	
WB 23	80	steady operation	250	30 000	100 000	Compressed Air
		180	400	50 000		
		120	500	60 000		
WB 27	150	steady operation	250	16 000	100 000	Compressed Air
		180	500	32 000		
		45	1 000	63 000		

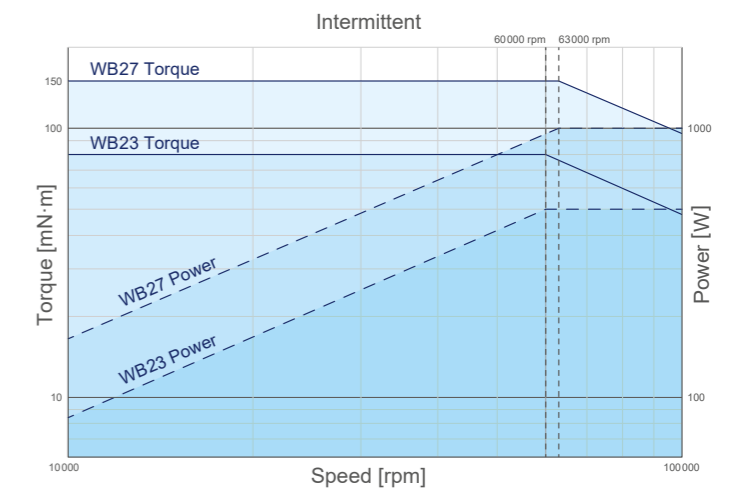
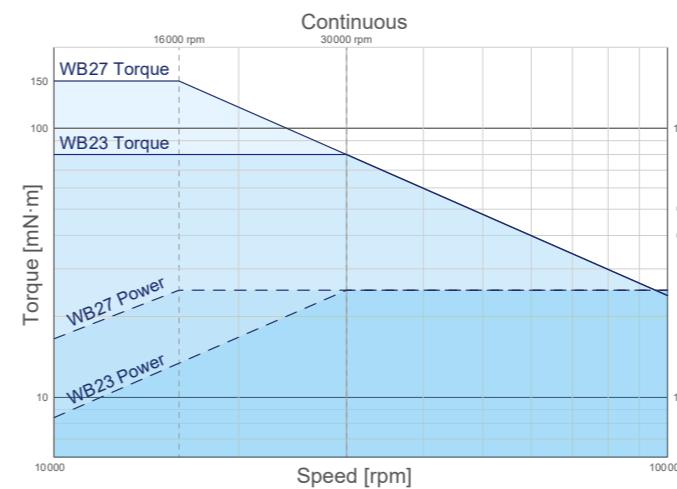

PB SERIES Powder Dynamometers

Industrial & High Torque Magnetic Powder Dynamometers



Powder Brake Dynamometers (PB Series) are ideal for applications operating in the low to middle speed range or when operating in the middle to high torque range. Powder Brakes provide full torque at zero speed and are water-cooled, allowing for power ratings up to 48 kW. PB Series Powder Dynamometers integrate a torque measuring system with an accuracy ratings $\pm 0.3 \dots \pm 0.5\%$ full scale, depending on size and system configuration.

- 12 Models Standard with Maximum Torque: 0.6... 1200 N·m
- Braking Power: 0.15 ... 48 kW
- Stable Braking Torque
- Low Moment of Inertia
- Operation in Either Rotational Direction
- Braking Torque Measurement Integrated
- Integrated Optical Speed Sensor
- Special designs available upon request

DYNAMOMETER RATINGS				
MODEL	RATED TORQUE	RATED POWER	RATED SPEED	MAX. SPEED
	N·m	kW	rpm	rpm
1PB2.7	0.6	0.15	2390	10000
2PB2.7	1.2	0.3		
4PB2.7	2.4	0.6		
1PB43	5.0	0.5	955	4000
2PB43	10.0	1.0		
1PB65	25	1.5	570	3000
2PB65	50	3.0		
1PB115	100	5.0	480	3000
2PB115	200	10.0		
1PB15	300	12.0	382	2000
2PB15	600	24.0		
4PB15	1200	48.0		

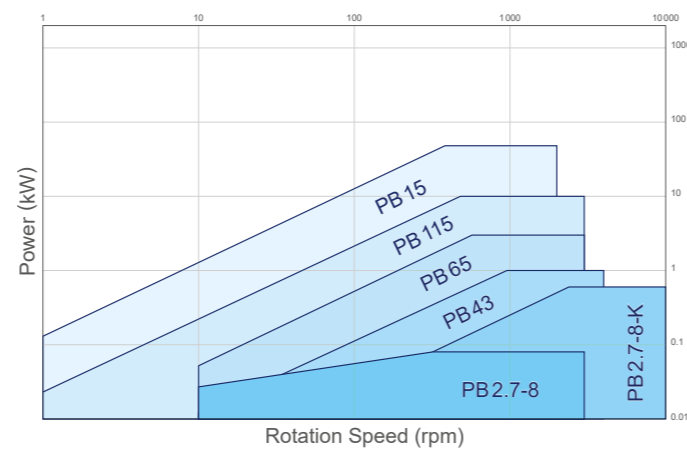
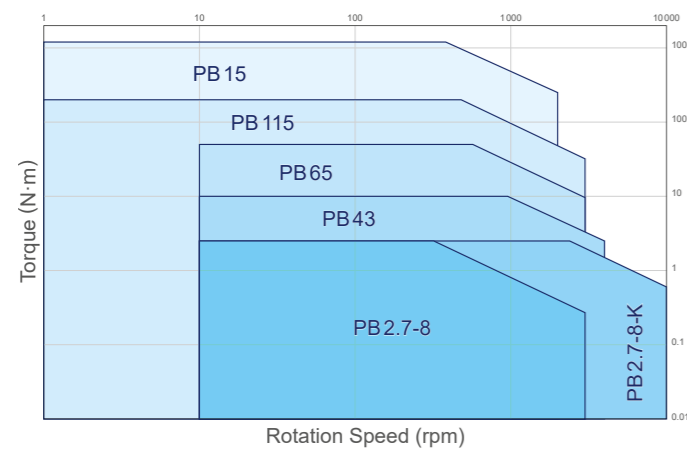

TANDEM SERIES In-Line Double Dynamometers

Two Dynamometers, Eddy-Current & Powder mounted in line



Eddy-current Brake Dynamometers (WB Series) provide increasing torque as the speed increases, reaching peak torque at rated speed. They are ideal for applications requiring high speeds and also when operating in the middle to high power range.

Powder Brake Dynamometers (PB Series) provide full torque at zero speed and are ideal for applications operating in the low to middle speed range or when operating in the middle to high torque range.

TANDEM Dynamometers are based on the combination of Eddy-current Dynamometers (WB Series) and Powder Dynamometers (PB Series) mounted in line on a common base and connected by an electromagnetic clutch. Both dynamometers are cooled by a water circulation system, which passes inside the stator to dissipate heat generated by the braking power, allowing a power rating up to 140 kW.

Both WB and PB Dynamometers integrates a torque measurement system with accuracy ratings of $\pm 0.3\%$ to $\pm 0.5\%$ full scale, depending on size and system configuration.

- 13 Models Standard with Maximum Torque: 5 N·m ... 1200 N·m
- Braking Power: 3... 140kW
- Stable Braking Torque, without Shock
- Low Moment of Inertia
- Operating Direction CW/CCW
- Braking Torque Measurement Integrated
- Integrated Optical Speed Sensor
- Special designs available upon request

COMBINING SPEED & HIGH LOAD

At low speeds, the TANDEM System benefits from high torque load provided by the PB Series Powder Dynamometer. An electromagnetic clutch will automatically switch off at the maximum speed of the PB Powder Dynamometer and automatically switch on at zero speed. Once the system is running over the PB Powder Dynamometer speed limit, the clutch cannot be switched on until the system returns to 0rpm (no longer rotating).

DYNAMOMETER RATINGS				
MODEL	RATED TORQUE	RATED POWER	PB MAX. SPEED ^{a)}	MAX. SPEED
	N·m	kW	rpm	rpm
2WB43 + 1PB43	5	3	4000	25000
2WB43 + 2PB43	10			
2WB65 + 1PB65	25	12	3000	18000
2WB65 + 2PB65	50			
2WB115 + 1PB115	100	30	3000	15000
2WB115 + 2PB115	200			
2WB115 + 2WB115	200	60	2000	7500
2WB15 + 1PB15	300	70		
2WB15 + 2PB15	600			
2WB15 + 4PB15	1200			
4WB15 + 1PB15	300	140		
4WB15 + 2PB15	600			
4WB15 + 4PB15	1200			

a) At this speed the coupling disengages and the WB Series brake operates.

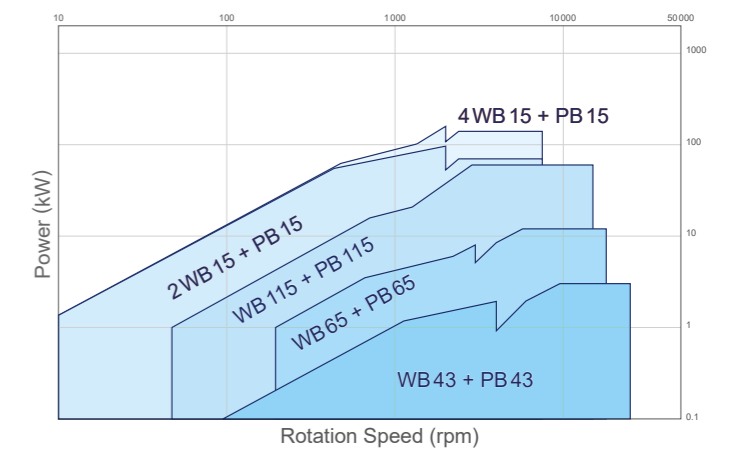
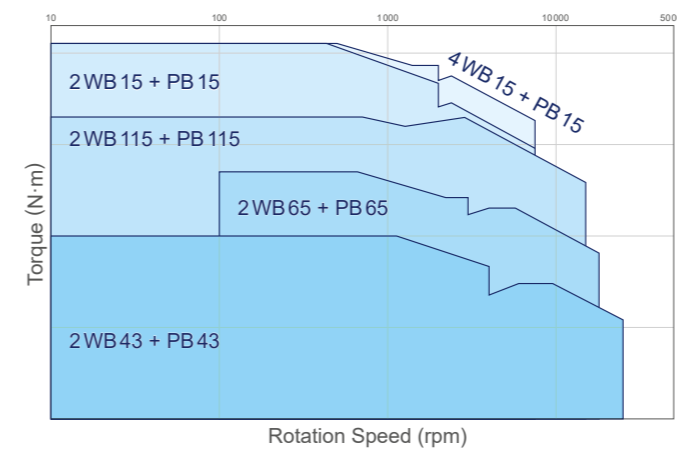

MSD Mega Speed Dynamometer

All-in-one system to test high speed motors and medical devices



The MSD - Mega Speed Dynamometer was developed for the testing of very high speed motors such as BLDC, dental turbine and surgical tools. The braking effect is based on Eddy-Current induced on an aluminum disc directly mounted on the MUT (Motor Under Test) shaft.

- Test Bench with Mechanical Protection
- Contactless Eddy-Current Brake System
- Speed Sensor
- Infra Red Temperature Sensor
- Built-in Reaction Torque Sensor (RT 200 Series)
- Dentistry - Handpiece and Motor Testing according to ISO14457:2017
- Available in version 20 or 50 mN·m (other ranges available on request)
- Accuracy ±0.2%
- Very Low Inertia ~8x10⁻⁹ Kg·m²
- No Residual Torque (no bearing) or friction
- Torque/Speed Acquisition Software (MSD-TEST)

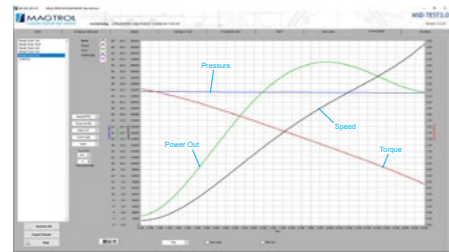

Torque is measured frictionless by a Reaction Torque Sensor mounted under the test bench surface. Due to the thermal effect on the disc, the Mega Speed Dynamometer is not suitable for endurance testing, but can be used to generate a fast curve or perform point to point testing. An infrared sensor monitors the temperature of the disc and stops the test in case of overheating. The disc can be designed and sized according to the motor parameters.

The system is contactless therefore alignment is not critical. Due to this, the system has very low inertia and therefore no residual or drag torque thus having less influence on testing parameters. The speed limitation is based on the Motor Under Test and its ability to drive the disc. Systems reaching speeds of 380000 rpm have already been manufactured.

MSD-TEST Software is developed in a LabVIEW™ environment. It controls the system and captures the test data. It allows the programming set up of a dedicated test profile.

Every Mega Speed Dynamometer will be designed around motor characteristics and performances to match the best possible test results. Specific motor fixtures will be designed to suit each motor form and dimensions.

The Mega Speed Dynamometer (MSD System) enhances Magtrol's expertise in high-speed applications and ideally complements of WB 23 & WB 27 Dynamometers enabling motor testing up to 100000 rpm.

The MSD-TEST Software (included) allows the configuration of the system as well as the programming of the test sequences and set-up. It displays test curves and data during testing while recording all measured values as data table and txt files. Parameters can be displayed in graphic form (up to 5 axes simultaneously). It is also easy to print or export the data as a Microsoft® Excel spreadsheet



Play Video

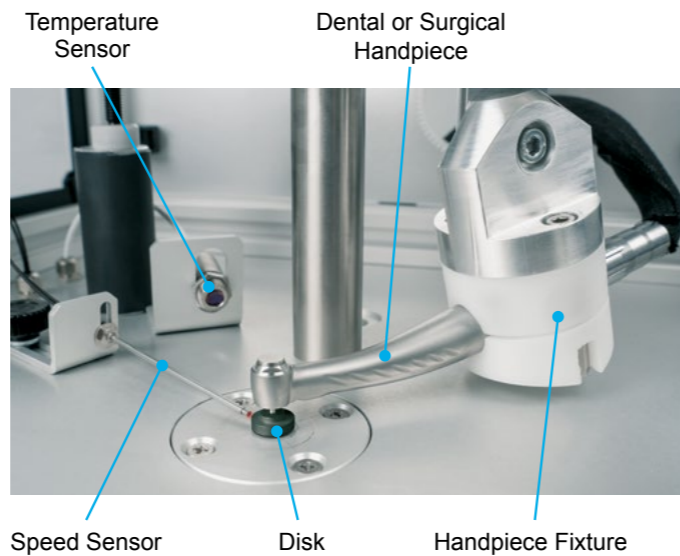
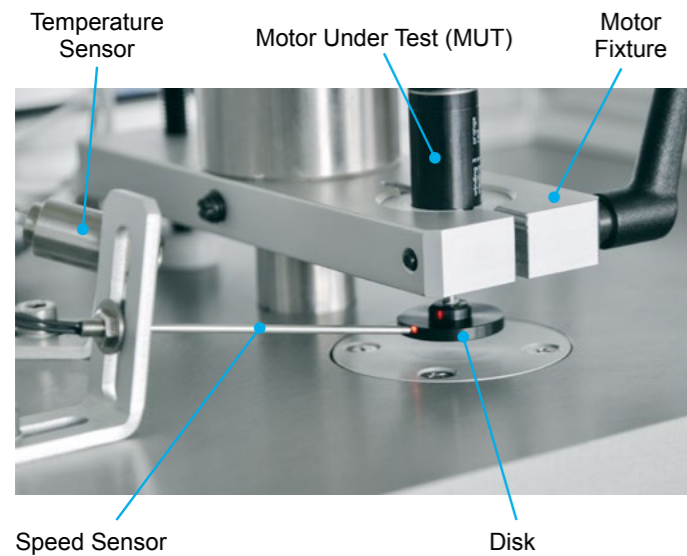

4Q Dynamometer Test System

4 Quadrant Active Dynamometer with regenerative motor drive

In addition to its wide range of hysteresis, powder and eddy current dynamometers, Magtrol provides 4 quadrant dynamometers offering motoring as well as loading capabilities. For a world-wide leader in pumps manufacturing, Magtrol has supplied a very efficient and versatile 37 kW AC dynamometer. The system offers complete testing in motoring or loading function capable of simulating real-world in-use conditions.

It offers following features:

- High dynamic torque / speed control
- Full torque from zero speed
- Full regenerative capability, returning power to AC mains (energy saving)
- Dedicated software control and data acquisition with automated test report issue and / or data downloading (Excel, CSV or text file)
- High accurate torque measurement (0.1%)
- Electric motor performance testing to IEC-60034 and derivatives
- Complete load data (torque, speed, current, efficiency, power input, power output, temperature, resistance), temperature rise and related data, during motor operation
- Robust industrial design for long terms operation stability

This Magtrol AC Dynamometer uses a dynamic adjustable load with a servomotor that produced loading function to the motor under test. The loading motor operates as a generator, returning the energy back into the main line power supply through the servo drive and regenerative unit. The system presented below (37 kW AC Dynamometer) provides torque up to 220 N·m and works in a speed range up to 4500 rpm. The system integrates a Magtrol In-Line TM 312 Torque Sensor (200 N·m, 0.1% accuracy) as well as electrically controlled safety coupling guards. The base plate is mounted on a robust steel welded frame with adjustable feet supports. An easy to move connection box allows positioning at any place next by the motor under test for measuring connections. The control rack integrates all the measuring & control instruments as well as PC, monitor and keyboard.

Based on its experience, Magtrol has already produced many systems completely adapted to the various needs (power, torque, speed, ...) of our customers.

Easy to use, Magtrol M-Test Software enables the user to quickly set test parameters and sequences, torque or speed control, or close or open loop. Test setups and can be saved and recalled any time. The data generated from this user-friendly program can be stored, displayed and printed in tabular, graphical formats or universal data reports and is easily imported into a spreadsheet.





MODEL 7500 Power Analyzer

Stand-alone power analyzer for DC and low frequency power measurement



The Magtrol MODEL 7500 Power Analyzer is an easy-to-use instrument ideal for numerous power measurement applications. From DC to 80 kHz AC, the MODEL 7500 measures volts, amps, watts, volt-amps, frequency, crest factor, V-Peak, A-Peak and power factor in one convenient display.

They may be used either as stand-alone instruments or in conjunction with any Magtrol Hysteresis, Eddy-Current or Powder Brake Dynamometer; any Magtrol Dynamometer Controller and M-TEST Software for more demanding motor test applications.

- Single/Three-Phase Capabilities: For single (7510) or three-phase (7530) power measurements
- Ranges: Up to 600V_{rms} @ 20A continuous duty
- Interfaces: USB & GPIB (IEEE-488)
- CAT II 1000V inputs
- Data Transfer Rates: ≤ 100/second
- Accuracy: ≤ 0.1 %
- Measurement: Continuous or cycle-by-cycle
- Vacuum Fluorescent Display: High-quality, easy to-read, customizable readout displays volts, amps, power and power factor
- Bandwidth: DC ≤ 80 kHz kHz (not suitable for PWM nor BLDC)
- Power supply: 85~264 V AC, 60~50Hz power @ 20 VA max.
- Auto Ranging: Automatically scales instrument for most accurate range
- Isolation: 1000V_{rms} to earth, 750V_{rms} line-to-line
- Average: Displays running average of amps, volts and watts
- Peak Hold: Stores the highest value.
- Values can include amps, watts and volts in any combination
- External Shunt Input
- Calibration Certificate: NIST Traceable
- Rack Mounting: 19" (482.6 mm) with handles

Electronics & Software

In addition to its mechanical components, Magtrol offers a range of equipment to ensure the highest accuracy throughout the measurement chain. This equipment is the result of over 60 years of experience, know-how and collaboration with our customers. Due to their reliable and ergonomic designs, they are the ideal complement to all of Magtrol's torque transducers

and/or dynamometers. They can be easily integrated into any measurement system. Capitalize Data acquisition is available through our range of dedicated computer software programs. For specific requirements, our software engineers are at your disposal to customize your measurement system.

DSP 7000 High Speed Programmable Controller

High Speed Programmable Controller for use with all Dynamometers



Magtrol's MODEL DSP 7000 High Speed Programmable Dynamometer Controller employs state-of-the-art Digital Signal Processing Technology to provide superior motor testing capabilities. Designed for use with any Magtrol Hysteresis, Eddy-Current or Powder Dynamometer, Magtrol In-Line Torque Transducer or auxiliary instrumentation, the DSP 7000 can provide complete PC control via the USB and GPIB (IEEE-488) interface. With up to 500 readings per second, the DSP 7000 is ideally suited for both the test lab and the production line.

- **DSP 70X1 Single Channel:** easy to use Plug & Play solution
- **DSP 70X2 Dual Channel:** Enables the support of two testing instruments with independent or tandem configurations and two fully independent control loops
- Built-in Alarm System
- Speed & Torque closed loop Operating Modes
- Programmable Digital PID Values
- Built-in Current-Regulated Supply

In the laboratory, the DSP 7000's high sample rate provides superior resolution for data acquisition and curve plotting. This allows for capturing more usable motor test data during switching, breakdown and other transitional areas of the motor test curve. For production and incoming inspection, the DSP 7000 displays torque, speed and power at all times, allowing the Controller to be used as a manual stand alone unit or as part of a complete PC system.

TSC SERIES Torque & Speed Conditioners

Torque & Speed Conditioner for Eddy-Current or Powder Dynamometers



The TSC Series is the Torque & Speed Conditioner used to connect Magtrol Eddy-Current (WB Series) or Powder (PB Series) Dynamometers to the DSP 7000 Controller.

Powered by the DSP 7000, and based on a precision instrumentation amplifier, the unit amplifies and filters the torque signal. It also provides power supply and connections for the speed pickup sensor which is located in the dynamometer.

DES SERIES Power Supplies

Power Supplies designed for the Eddy-Current & Powder Brake Dynamometers



DES Series Power Supplies are specially designed for the full range of Magtrol's Eddy-Current and Powder Brake dynamometers with the design goal providing the best response time. The DES Series supplies are packaged in an industrial housing made of cast aluminum. This offers superior protection against radiated emissions in order to avoid any disruption of the surrounding electronics modules. This housing must be installed directly on the test bench, next to the brake, as close as possible.

The DES Series supplies can be controlled by digital signals and analog set point coming from peripheral electronics. The DSP 7000 Dynamometer Controller has been designed to work with the DES Series.

- For use with Magtrol WB Eddy-Current and PB Powder Brake Dynamometers
- Controlled Current Power Supply, with overvoltage factor > 5
- Analog Input for current set-point
- Selection of nominal current
- Control by digital inputs/outputs
- General alarm provided by relay
- Power Supply: 115 / 230 VAC
- Built-in Alarm Temperature & Electric

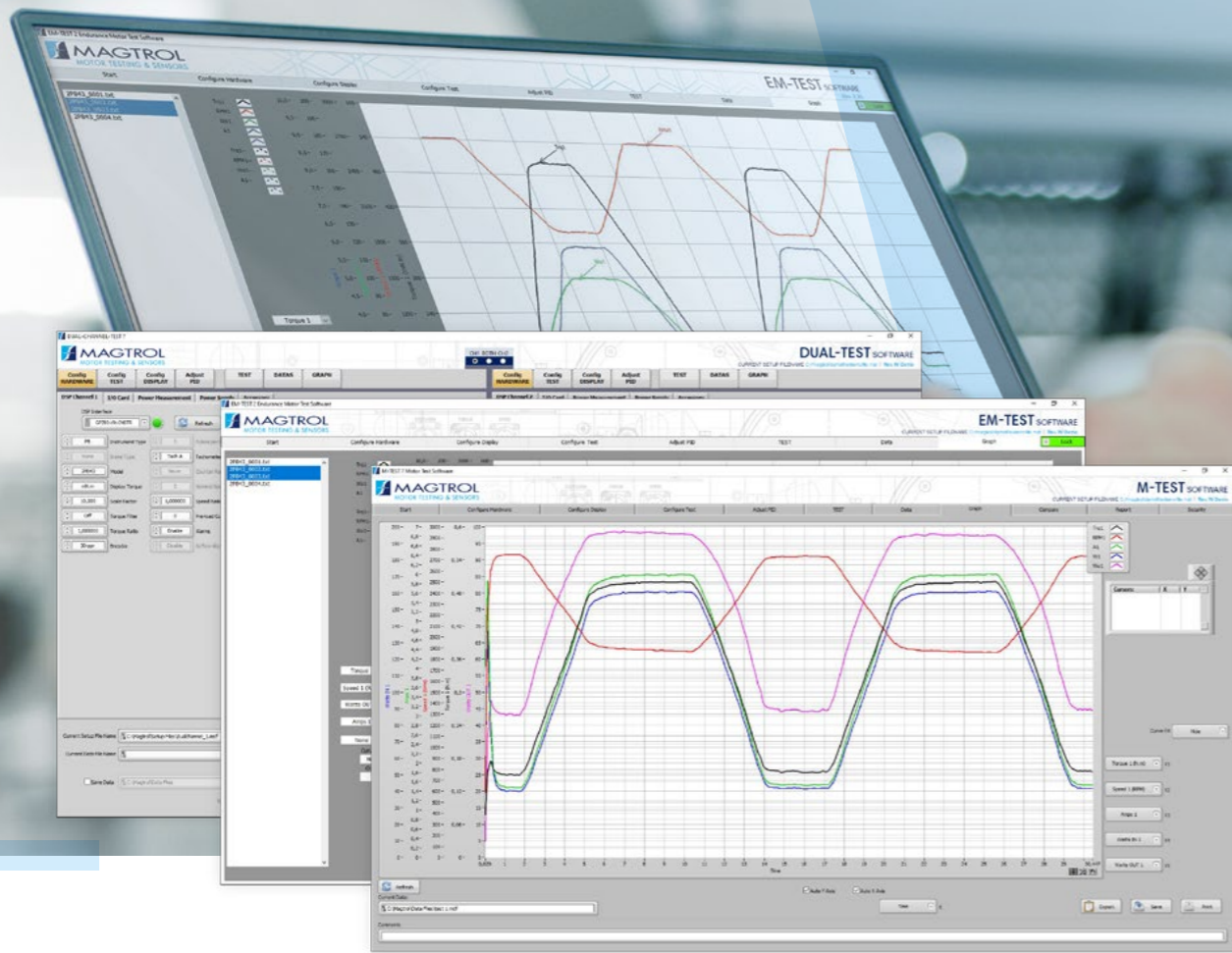

M-TEST Motor Testing Software

For test management and data acquisition

Magtrol's M-TEST is a state-of-the-art motor testing program for PC (Windows®) based data acquisition. Used with a Magtrol Programmable Dynamometer Controller (DSP 7000 Series), M-TEST works with any Magtrol Dynamometer (WB, PB, HD Series) or In-Line Torque Transducer (TM, TS Series) to help determine the performance characteristics of a motor under test. The parameters are calculated and displayed utilizing M-TEST's feature-rich testing and graphing capabilities.

An integral component of any Magtrol Motor Test System, M-TEST performs ramp, curve, manual, pass/fail, Temperature Test and Running Heating Temperature tests in a manner best

suited to the overall efficiency of the test rig. Written in LabVIEW™, M-TEST has the flexibility to test a variety of motors in a multitude of configurations.

The data generated from this user-friendly program can be stored, displayed and printed in tabular or graphical formats, and is easily imported into a spreadsheet.

Magtrol M-TEST Software already integrates the interface to many market's Power Analyzers (Yokogawa, Zimmer, Hioki, Infratec, Newtons4th, etc) and Power Supply which can easily be selected from a library.

EM-TEST Endurance Motor Testing Software

Determines the performance characteristics of a motor under test

Magtrol's EM-TEST is an Endurance Motor Testing Software for PC (Windows®) based data acquisition. Combined with a Magtrol DSP 7000 Series High Speed Programmable Controller, EM-TEST works with any Magtrol Dynamometer (WB, PB, HD Series) or In-Line Torque Transducer (TM, TS Series) to determine the performance characteristics of a motor under test.

EM-TEST performs curve testing in a manner best suited to the overall efficiency of the test rig. Written in LabVIEW™, EM-TEST has the flexibility to test a variety of motors in a multitude of configurations. The data generated from this user-friendly program can be stored, displayed and printed in tabular or graphical formats, and is easily imported into a spreadsheet.

Compared to M-TEST software, EM-TEST is designed for long-term motor test cycling. It includes a recovery functions allowing to recover testing by computer crash without losing data and avoiding to start the test over again. Any aborted test can be re-starts where it stops, keeping all the data of the past testing cycles or hours.

It is also possible to program the saving sampling frequency, for example every 10 our 20 cycles data saving, keeping complete data for the last 30 minutes of testing. It is highly recommended for any duration test with repeated cycles which will last for a certain period of time (1 hour and more).

DUAL-TEST Dual Motor Testing Software

Testing on two channels independently

Magtrol's DUAL-TEST is a state-of-the-art motor testing software for PC (Windows®) based data acquisition. Used with a Magtrol Programmable Dynamometer Controller DSP 7002, DUAL-TEST works on two channels independently with any Magtrol Dynamometer (WB, PB, HD Series) or In-Line Torque Transducer (TM, TS Series) to determine the performance characteristics of a motors under test.

The parameters are calculated and displayed utilizing DUAL-TEST's feature-rich testing and graphing capabilities. An integral component of any Magtrol Motor Test System, DUAL-

TEST performs curve tests in a manner best suited to the overall efficiency of the test rig. Written in LabVIEW™, DUAL-TEST has the flexibility to test a variety of motors in a multitude of configurations.

The data generated from this user-friendly program can be stored, displayed and printed in tabular or graphical formats, and is easily imported into a spreadsheet. Compared to M-TEST software, DUAL-TEST is designed to create two independent Curves profile on 2 channels.

IEC-TEST Motor Testing Software

Determines motor efficiency according to IEC-60034

Magtrol IEC-TEST software provides a fully automated implementation of IEC 60034-2-1 standards. It directly integrates the efficiency determination with automatic motor and ambient temperature measurements, stator winding resistance measurements, load curve test, no load test, torque – speed – voltage measurements.

All the testing and data acquisition will be automatically controlled by the system with resistance and temperature measurements, load tests repeated at 125%, 115%, 100%, 75%, 50% and 25% of rated power as well as no load testing as requested by the norms. It generates a complete test certificate as shown here.

In addition to the automatic testing functions which run the test one after the other, the system offers the ability to run each test individually in manual mode. IEC-TEST can use Load Motor (4 Quadrant) systems or any dynamometer system (2 Quadrant).

IEC-60034-2-1 STANDARD

Efficiency determination is a key factor in the next generation of motor and drive technology in reducing energy consumption and waste through more efficient systems. The international standards defined a norm regarding the efficiency determination by specifying methods for determining specific loss in motor & drives systems. The efficiency determination by the method of the summation of losses is a test method in which the efficiency is determined by the summation of separate losses (Iron loss, Windage and friction losses, Stator and rotor copper Losses). The efficiency measurement of a rotating machine is determined by computing torque and speed (mechanical output power) data in comparison with voltage and current measurements (electrical output power) over time.

MOTOR DESCRIPTION	
Rated output power	kW 0.12
Rated voltage	V 230
Rated current	A 1.13
Rated speed	min ⁻¹ 1380
Supply frequency	Hz 50
Number of Phases	3
IEC 60034-30-1 (rated)	IE-Code IE2
Manufacturer	EMK
Model Nr.	WA61A34-4B3-B
Serial Nr.	717019110108
Duty type IEC 60034-1	S1
Design	-
Insulation class IEC 60085	F
Max. ambient temperature	°C 25

INITIAL MOTOR CONDITIONS		6.1.3.2.1 - RATED LOAD TEST	
Test resistance R _L	Ω 29.93	Test resistance R _L	Ω 37.137
Winding temperature θ _w	°C 24.187	Winding temperature θ _w	°C 50.309
Ambient temperature θ _a	°C 21.067	Ambient temperature θ _a	°C 21.58

6.1.3.2.3 - LOAD CURVES TEST	
Rated output power	% 125% 115% 100% 75% 50% 25%
Torque T	Nm 1.028 0.95 0.813 0.603 0.396 0.195
Input power P ₁	W 237.122 245.529 228.953 205.507 186.35 169.888
Line current I _L	A 1.186 1.15 1.098 1.048 1.028 1.039
Operating Speed n ₁	min ⁻¹ 1385.82 1396.6 1414.03 1436.74 1457.34 1475.74
Terminal voltage U _L	V 230.177 230.333 230.337 230.228 230.393 230.279
Frequency f	Hz 49.977 49.978 49.978 49.977 49.977 49.978
Winding temperature θ _w	°C 56.442 56.447 56.447 56.42 56.409 56.38
Test resistance before load test	R Ω 35.67

6.1.3.2.4 - NO-LOAD TEST	
Rated voltage	% 110% 100% 95% 90% 80% 40% 30%
Input power P ₀	W 239.573 165.201 127.173 103.743 86.777 26.491 16.551 9.752
Line current I ₀	A 1.535 1.118 0.88 0.718 0.279 0.232 0.183 0.144
Terminal voltage U ₀	V 253.252 232.636 218.852 207.387 198.325 117.308 92.219 69.138
Frequency f ₀	Hz 49.979 49.976 49.975 49.977 49.977 49.973 49.976 49.976
W. temperature θ _w	°C 56.162 56.131 56.113 56.097 56.032 56.009 55.978 55.978
Test resistance after no-load test	R Ω 36.23

6.1.3.3 - EFFICIENCY DETERMINATION	
Rated output power corr.	P _{2a} % 125% 115% 100% 75% 50% 25%
Output power corrected	P _{2a} W 150.938 140.570 121.800 91.790 61.144 30.489
Slip corrected	S _{2a} p.u 0.035 0.042 0.064 0.069 0.083 0.095
Input power corrected	P _{1a} W 260.141 249.423 231.671 208.021 188.548 171.862
Iron losses	P _{iron} W 155.756 156.219 156.231 143.989 134.952 127.086
Frict. And wind. Losses corr.	P _{frict} W 0.238 0.238 0.238 0.238 0.238 0.238
Additional-load losses	P _L W -38.016 -32.466 -23.777 -13.080 -5.641 -1.368
Stator losses corrected	P _{st} W 0.000 0.000 0.000 0.000 0.000 0.000
Rotor losses corrected	P _{rot} W 7.807 6.298 4.219 2.201 0.934 0.216
Power factor	cos φ 0.942 0.931 0.905 0.852 0.787 0.710
Efficiency	η % 54.255 51.606 46.789 38.754 28.750 16.212

Tested by: Adam SMITH Approved by: Gerhart HÜBERS

Based on their specific efficiency results, electric motors can be classified in different classes according to IEC 60034-30: IE1 (standard efficiency), IE2 (high efficiency), IE3 (premium efficiency), and IE4 (super premium efficiency). The below table shows minimum efficiency required for the classification of a 15 kW 4-pole AC motor (50 Hz).

IE1 (Standard)	IE2 (High)	IE3 (Premium)	IE4 (Super)
88.7 %	90.6 %	92.1 %	93.9 %

System Options & Accessories

Accessories are essential for the implementation of measuring systems. With the addition of some of these accessories, integration of test benches or measuring systems can facilitate the functionality of complete tests. The options and accessories are able to make your test system ergonomic.

Customization is one of Magtrol's core competencies. For more than 60 years we have been designing custom solutions. Our expertise allows us to offer proven solutions in the fields of fastening, coupling, furniture, cooling, ...

SBB Signal Breakout Box

Magtrol's SBB - Signal Breakout Box is designed to assist in the monitoring of speed, torque and index signals obtained from either a Magtrol dynamometer or torque transducer. The easy-to-use SBB is simply inserted in series between a Magtrol controller and any Magtrol dynamometer or torque transducer. Connections with Torque sensor, Dynamometer and High Speed Controller (DSP 701X) are done via D-Sub 15-pin signal cables.

Speed, torque and index signals are then outputted through BNC connectors to an oscilloscope or other DAQ instrumentation device. A toggle switch allows switching between the encoder of the torque transducer and an external encoder wired to the encoder input. The SBB - Signal Breakout Box is a convenient and reliable accessory that reduces the necessary wiring required for signal monitoring.



FOR EACH INQUIRY A SPECIFIC SOLUTION

The small test bench shown here is a good example of the know-how of the Magtrol's CMTS department (Custom Motor Test System).

In this situation, the customer expressed the request to test motors with HD System, but with number of different frame sizes.

Instead of manufacturing different fixtures for each sizes, Magtrol integrated a robust, high-precision mobile table. This design also made it possible to integrate a blower creating a very compact system.

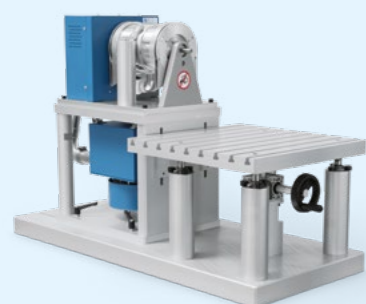

AMF SERIES Adjustable Motor Fixtures



Magtrol's AMF Series Adjustable Motor Fixtures are used to secure small to medium-sized motors in place while running any test. These extremely versatile fixtures also enable easy motor centering for coupling to a Magtrol HD Series Hysteresis Dynamometer (Couplings can be supplied upon request). Various motor lengths are accommodated by either an attached T-slot base plate or sliding base, depending on the model.

The AMF-1, -2 and -3 Fixtures feature one or two adjustable bridges, each fitted with a fluted knob clamp screw, to allow clamping anywhere along the axis of the motor. The adjustable bridge on the AMF-V Fixture incorporates a straight-line action clamp with a V-angle rubber padded clamp to maximize the mounting area.

To safeguard the motor, locking thumb screws provide protection against vibration and all motor-to-fixture contact surfaces are nylon padded for scratch-free clamping.

FMF SERIES Fixed Motor Fixtures

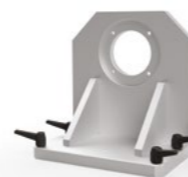

Originally designed to test window lift gear motors, Magtrol's FMF Series Fixed Motor Fixtures are used to secure motors in place while running any test. These versatile fixtures align the motor under test with Magtrol's HD-100, HD-106, HD-400, HD-500, HD-700 and HD-800 Series Dynamometers for easy setup and coupling—couplings can be provided upon request. Various adaptor rings can be customized to allow several different motors to be tested on the same fixture.

FMF Fixed Motor Fixtures can be mounted to any Magtrol Dynamometer T-slotted long base plate or any Hysteresis Dynamometer Table with grooved table top (TAB 1457S, TAB 0800L and TAB 0825L). These fixtures are equipped with a precisely located rectangular key on the bottom of the plate for easy centering. Also included are four adjustable clamping levers and T-nuts.

FRS Free-Run Speed Sensor



Magtrol's FRS Free-Run Speed Sensor is designed for applications where it is necessary to acquire speed readings that are unaffected by drag load. Before connecting a motor to the dynamometer, the free-run speed can be obtained from the FRS Sensor. With its reflective sensor, the FRS does not need to be attached to the motor but only placed close to the motor shaft (as shown in the photo to the right). Note: For best contrast, the shaft should be marked with reflective tape.

The sensing end of the fiber optic assembly emits and receives light reflected from the shaft, and sends the speed signal to the digital fiber sensor. The raw speed data is then transmitted to either a Magtrol MODEL 3411 Torque Display or DSP7000 Dynamometer Controller where it is converted and displayed in rpm.

RTM SERIES Riser Kits for Torque Sensors



Magtrol's PT Series T-slot Base Plates are used for creating a basic test rig by mounting a Magtrol Dynamometer, Brake or Torque Transducer in line with the unit to be tested. Depending on the system configuration, a riser may be required to lift the transducer from the baseplate to the shaft height of the brake and/or the motor being tested. Magtrol RTM Riser Kits come complete with attachment hardware for the transducer and T-nuts and bolts for attachment to the PT Base Plate.

TAB SERIES Dynamometer Tables



Test from a stationary position or move a dynamometer to alternate testing stations with ease with Magtrol's Dynamometer Table. The stand is designed from lightweight aluminum with casters for smooth mobility, and is sturdy enough to support even the heaviest of Magtrol dynamometers. The design can be retrofitted to any Magtrol dynamometer and is easily reconfigured for added versatility.

PT SERIES T-Slot Base Plates

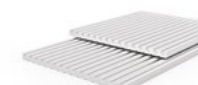

PT Series T-slot Base Plates are used for creating a basic test rig by mounting a Magtrol Dynamometer and/or Torque Transducer in line with the unit to be tested. Its solid, warp-resistant structure and multiple, single-sided T-slots enable modular construction that is cost-effective and easy to assemble.



Couplings

To ensure optimal use of its brakes, dynamometer and torque transducers, Magtrol provides a complete range of couplings specially selected for their mechanical characteristics. These couplings are perfectly sized and balanced to ensure accurate measurement and are fully customizable according to the diameters of the elements to be connected. When designing a system, we invite you to contact our specialized engineers who will be pleased to support and advise you.

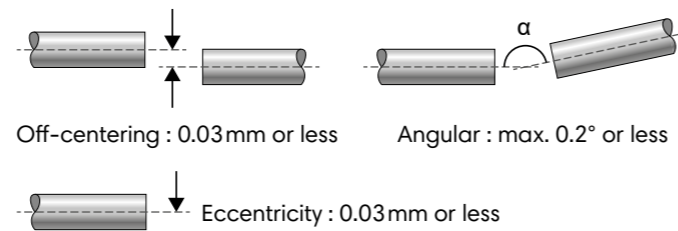

SUSPENDED OR SUPPORTED INSTALLATION ?

Our torque transducers are suitable for use in a supported or suspended configuration. Depending on the model, Magtrol offers versions specifically designed for suspended mounting (e.g. TMB). The assembly of a measuring train must always be done with the utmost care. The connection between the equipment (sensor, brake, motor,...) must always be made by means of couplings to reduce alignment errors.

SUPPORTED INSTALLATION

It is the configuration that Magtrol recommends and that will be used in most cases. It is ideal for standard measurement systems and **is necessary for demanding, high accuracy or high speed measurements**. In this configuration, the torque transducer is mounted on a rigid baseplate by means of an intermediate holder (e.g. RTM Riser-kit, custom,...). As all rotating components (sensor, brake, motor,...) are mounted on a baseplate, pay attention not to induce parasitic forces (axial or radial) which could disturb the measurement. In this case, it is necessary to practice a correct alignment and to use couplings with two degrees of freedom such as the MIC-5, BKC,...

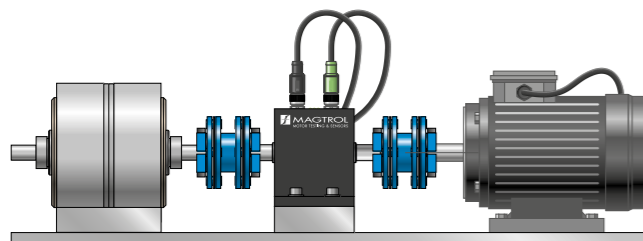

Supported installation
Mandatory for standard and high speed applications.

SUSPENDED INSTALLATION

This configuration is **only possible for low speed measurements**. Its main advantage is that it is more compact and less expensive (no support). As the transducer is not fixed to an external element, it is possible to connect it by means of two couplings with one degree of freedom. Care must be taken to ensure that the sensor's measurement is not distorted by any parasitic force, by the weight of the sensor (e.g. TS100-TS103) or by any other external intervention. The device can be used in both supported and suspended configurations. Supported configuration is recommended for the majority of applications (mandatory for high speed testing).

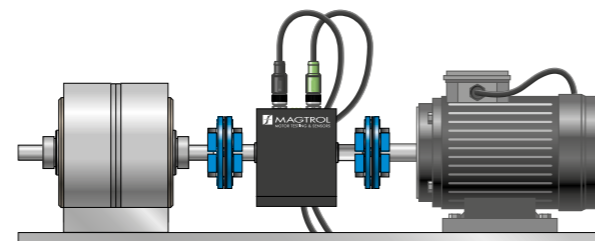

Suspended installation for low speed applications only.
A single element coupling can be used to create a shorter drive train

MIC SERIES Miniature Couplings

Single or Double Element Miniature Couplings



- For use with Magtrol TM, TMB, TMHS and TS Series In-Line Torque Transducers, as well as HD, WB and PB Dynamometers, and HB Brakes
- High Torsional Stiffness
- Low Inertia
- Low Weight
- High Rotational Speed
- Electrically Isolated Version (available on request)
- Full Diameter Range: 2.38 ... 28 mm
- Version with Double Clamping Screws (available on request)

The couplings consist of one (MIC-6) or two (MIC-5) disc packs, two clamping hubs and a spacer. They are both torsionally stiff and flexible in order to compensate for axial and angular misalignment when connecting two shaft ends. The MIC-5 (double-element coupling) also provides compensation for radial misalignment.

On demand, MIC Series coupling are available in electrically isolated version, suitable for temperature up to 100°C (125°C max. temperature, short term).

BKC SERIES Metal Bellows Couplings

For the transmission of large torque



- Metal bellows couplings for use with Magtrol TM, TMB, TMHS and TS Series In-Line Torque Transducers.
- Easy to mount
- High Torsional Stiffness
- Full Diameter Range: 12 ... 60 mm
- Radial Clamping Screw hub for smooth shaft.
- Ideal for the transmission of large torque

BKC - Metal Bellows Couplings provide the ideal complement to Magtrol's TM/TMB/TMHS/TS In-Line Torque Transducers and Sensors, when these are to be mounted in a drive train.

The torque transmission element consists of a metal bellows and 2 clamping hubs. The couplings are both torsionally stiff and flexible in order to compensate for axial, angular and radial misalignment when connecting two shaft ends. The high torsional spring rate of the couplings ensures a high torsional stiffness and angular precision.

BKC are made of highly flexible high-grade stainless steel, the hub material of aluminum or steel. With a single ISO 4762 radial clamping screw per hub.

KTF SERIES Disc Coupling for TF Sensors

Specially designed to match with Magtrol Torque Flange Sensors



- For specific use with Magtrol TF Series Torque Flange Sensors
- Compensation for axial, angular and radial misalignments
- Torsionally stiff
- Wear and maintenance-free
- Double-element
- Compact design
- High speed (up to 25000 rpm)
- Minimization of reaction forces
- G2.5 balancing according to ISO1940
- Stainless steel

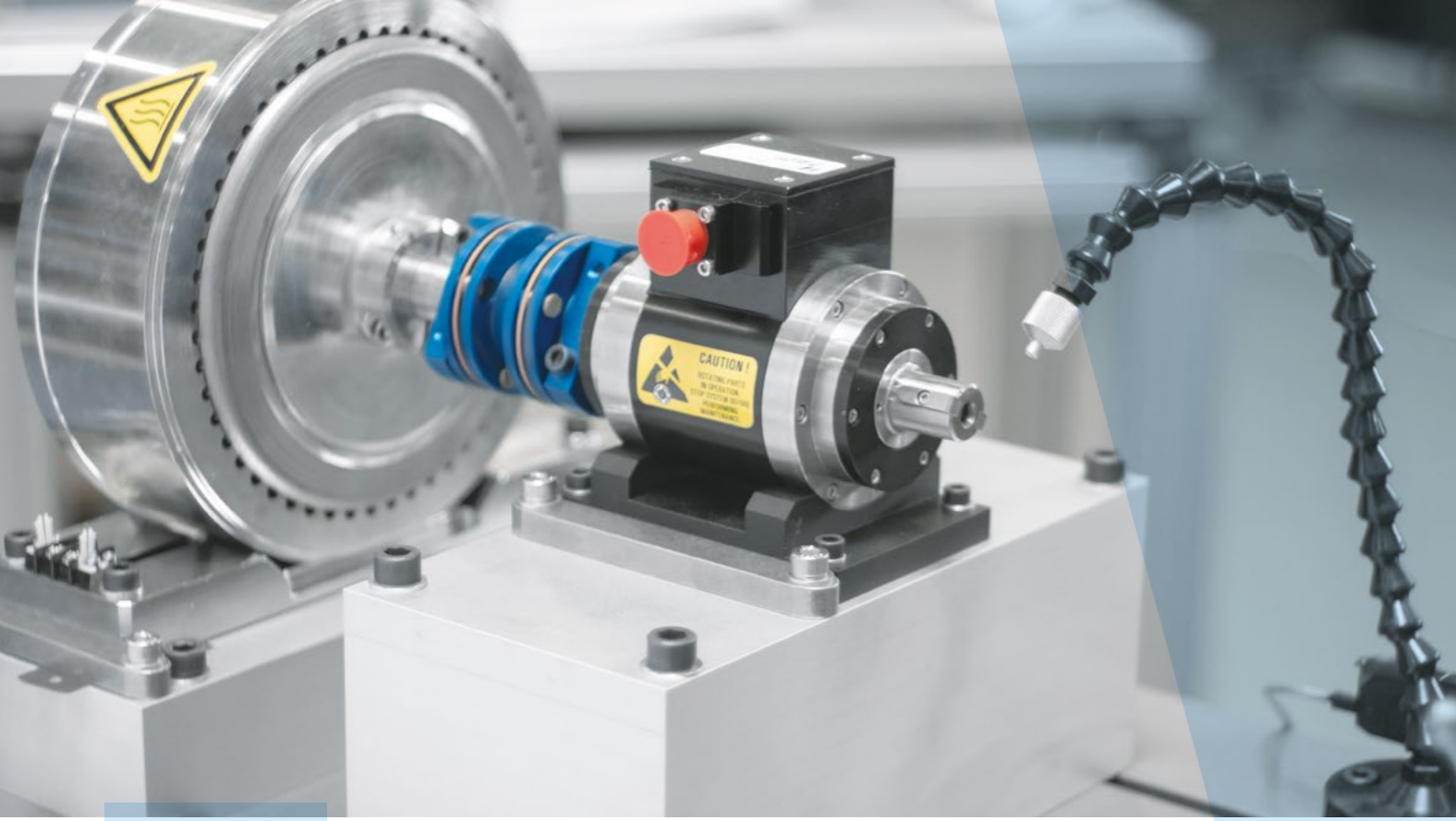

MMTS Modular Motor Test Systems

A new approach and intuitive way to build a test system

Drawing on its extensive experience with test systems, Magtrol offers a new approach to motor test systems. Magtrol's Modular Motor Test System (MMTS) offers a faster, more flexible and more scalable solution.

With the MMTS, building a test system becomes very simple. The multi-step process streamlines the required instrumentation to the initial specifications. The process allows for rapid evaluation of all usage contexts to ensure that all ancillary elements are integrated.

Depending on the specification, select the brake, the torque transducer, the coupling, the fixture and other items from Magtrol's product list. Then choose whether you want to assemble the test system yourself or have our specialists do it for you.

Throughout the process, our sales engineers and technical specialists will support and advise you in your choice. It is possible to delegate the assembly of the test bench to us. This method is particularly advantageous as it ensures that your test system is correctly assembled.

On request, our support technicians are at your disposal to assist you during the commissioning of your system. This can be done at our premises or directly at your site.

THINK MODULARITY AND CUSTOMIZATION

Thanks to the modular test system, you can design your test bench according to your specifications. Once the elements are selected, you will receive the components in the form of a kit to be assembled by your own means. Of course, we also provide the assembly of your modular system by our team of specialists. This way you will receive a test system assembled, calibrated and ready to use.

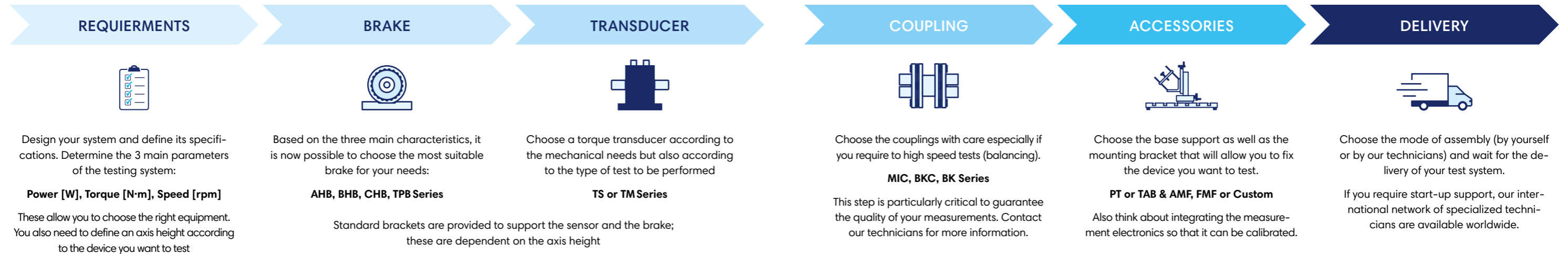
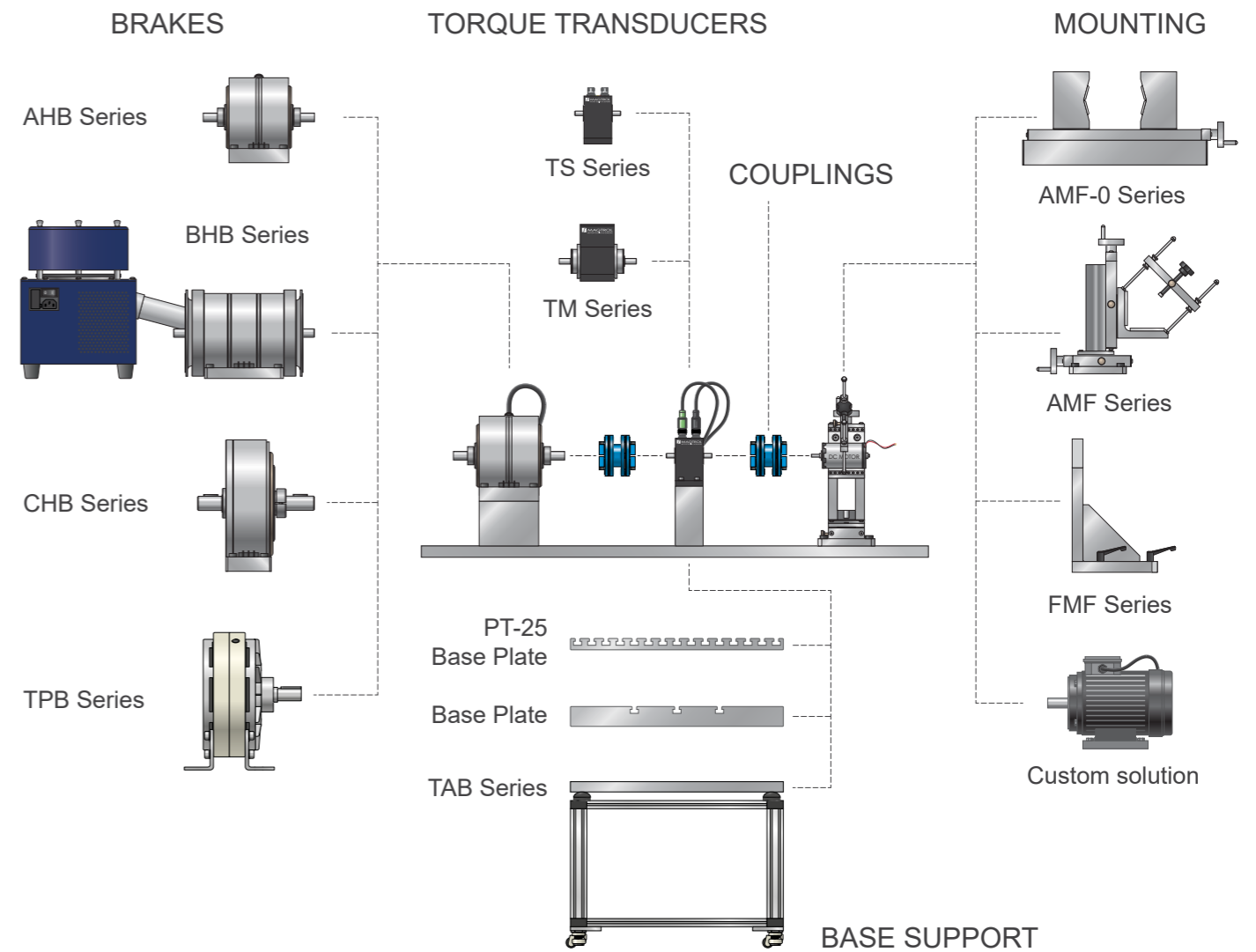

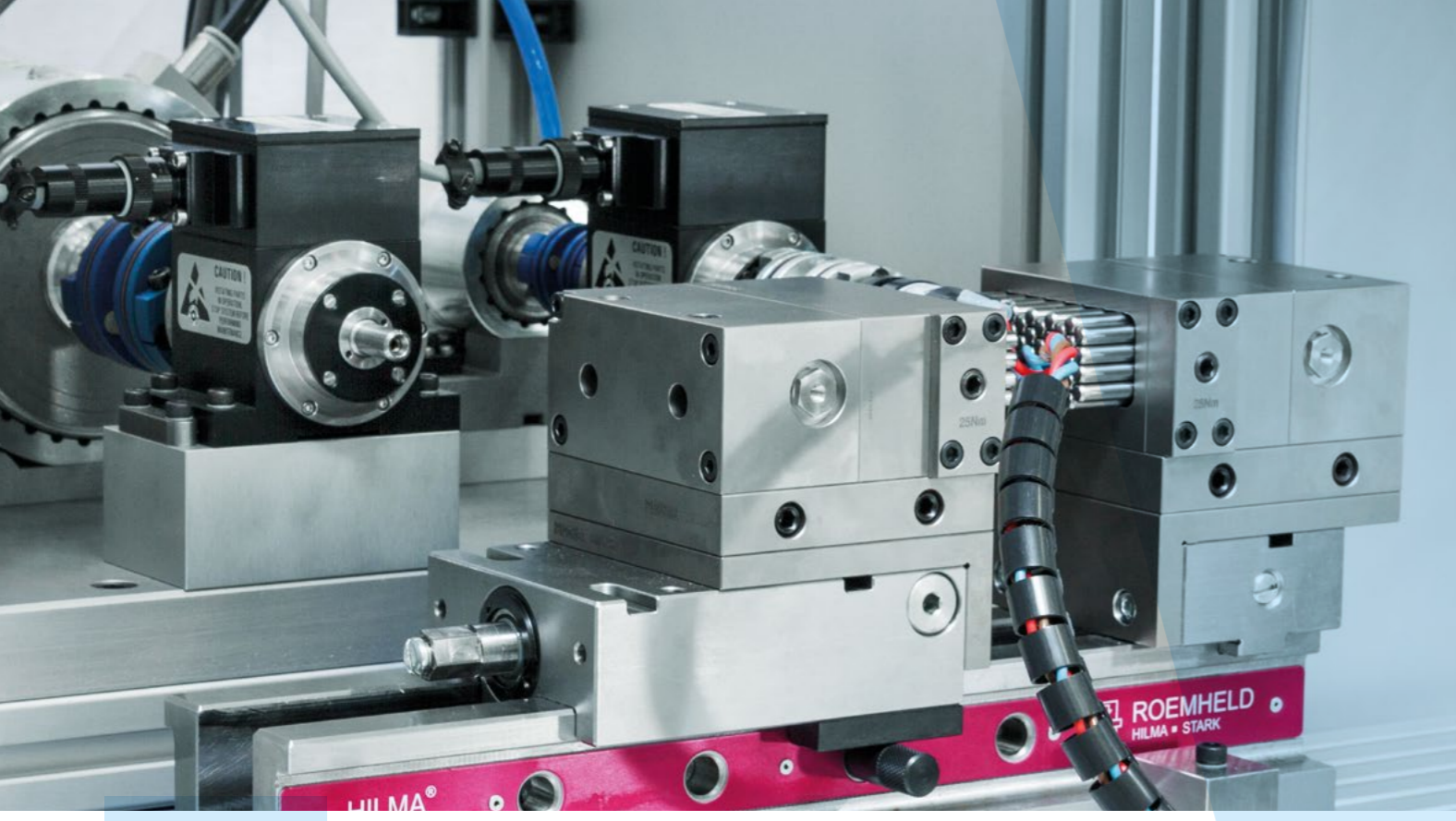

CMTS Custom Motor Test Systems

Like our customers, each test bench is unique

At Magtrol, we work with our customers to define their project requirements so that we can deliver a test bench that will perfectly match their needs. We take particular care to make our test benches ergonomic, versatile and scalable. Below are some examples of specific test benches:

INNOVATIVE MOTOR TESTING IN CLIMATE CHAMBER

Test your devices in real conditions with the innovative climate chamber for motor testing applications by Magtrol.

To comply with the ever changing market requirements in the field of thermal testing, Magtrol provides test systems that integrate a climate chamber to ensure real world simulations during testing. The system records motor performance in a temperature range from -40°C up to 150°C. Test sequences are executed at defined and stabilized temperature levels.

As an integral component of any Magtrol engine test system, the M-TEST software has been adapted to integrate the parameters of the environmental chamber to perform specific test cycles.



System for certification of automotive electric motors in specific climatic conditions

DOUBLE LINES CUSTOMIZED MOTOR TEST BENCH

To supply a world leader in the manufacture of do-it-yourself tools, chainsaws and lawnmowers, Magtrol designed a flexible, customized motor testing system including 2 parallel testing lines with 0.3 N-m and 6 N-m nominal ranges.

Each line is comprised of a Magtrol Inline TM Torque Sensor and AHB Air Cooled Brake mounted on the test bench. An X - Y cross table fixed on a Z vertical slide accommodates and adjusts each of the testing lines to the motor or tool under test.

A modular and flexible clamping system enables holding of testing samples with complex geometries and body shapes. The safety of the bench is fully assured by protection doors which cannot be opened during operation. A connection box located inside the bench cabinet allows the measuring connections to be located near the motor under test. A Control rack integrates all the measuring and control instruments as well as PC, monitor and keyboard. It includes a high-end Yokogawa WT1800 power analyzer, precision ohmmeters and a 100 VDC / 75 Amp power supply.

Completed by the M-TEST Software...

ALL-IN-ONE TURNKEY SYSTEM

At Magtrol, we have extensive knowledge of all the elements that make up the measurement chain. Whether it is the main mechanical components, accessories or electronics, we pride ourselves on offering turnkey systems. These have many advantages:

- Reduces compatibility issues between components.
- Time and cost saving
- Proven and reliable systems
- Compactness and mobility
- Ergonomic working environment



System with multiple lines to facilitate the testing of different devices with the same installation



Typical turnkey Test Bench. The test station is located on the top and is mechanically protected. The front side integrates the control panel, the connection interface, and the electronic measuring devices.

Custom Motor Test Benches & Systems

Following consultations with our customers, we noticed that they often encountered problems that made their measurement process tedious. In order to solve this problem, our engineers have been working intensively to propose the most optimized solutions. This is what led to the creation of our specialized Custom Motor Test Bench (CMTS) manufacturing department. Now, for over 60 years, Magtrol has been providing ingenious and reliable solutions.

In this field, each inquiry is specific in order to meet the needs of the components to be tested, the type of test to be performed, the frequency,... We are at your disposal to help you define your specifications and to assist you in the acquisition of said system adapted to your needs. Our knowledge is the guarantee to obtain a reliable solution (we manufacture all the components of measurement) and ergonomic (compact system, mobile,...).

WHICH APPLICATIONS FOR MOTOR TEST SYSTEMS ?

Custom Motor Test Systems can be used in many applications mainly to test and measure system integrating in an electric drive. The list below is not exhaustive and compiles applications for which Magtrol is regularly commissioned:

- Surgical and Dental Tools
- Analysis of the Biomechanical Performance of Sportsmen
- Large Industrial Ceiling Fan Motors
- Automotive Brushless Motor and Drive Solutions
- Aerospace Motors
- Aircraft Tachometers
- Appliance Motors
- Aircraft Motors
- Electric Pump Motors
- Starter Motors
- ABS Motors
- Hot Tub/Spa Pumps and Blowers
- Throttle Control Systems
- Linear Reducers
- Drum Motors
- Gear Motors
- Motorized Systems
- Aerospace Motor Systems
- Power Tool Motor Systems
- Electronic Personal Transportation Devices

WHAT DO MOTOR TEST SYSTEMS TYPICALLY INCLUDE ?

A Custom Motor Test System may contain any of the following:

- One or more dynamometers
- Programmable Dynamometer Controller (DSP 7000)
- Power analyzer (MODEL 7500)
- M-TEST Software (or custom variations)
- Motor power supply (AC and/or DC) for the Motor Under Test (MUT)
- Precision Ohmmeters
- Rack mounted computer, monitor and keyboard drawer.
- Dynamometer table or custom structure
- Motor fixturing for test motors (AMF, FMF,...)
- Temperature measurement hardware
- On-site commissioning & technical training

Magtrol M-TEST Software already integrates the interface to many market's Power Analyzers (Yokogawa, Zimmer, Hioki, Infratec, Newtons4th, etc) and Power Supplies which can easily be selected from a library.

Together, we make your projects a reality

EACH PROJECT REQUIRES A UNIQUE SOLUTION

Meeting your needs with customized solutions has been our company's mission since its creation.

Thanks to our size, we have the flexibility to meet all our customers' requirements. Whether you need a large series or a single part, our network of collaborators and subcontractors are organized to provide the best service according to your specific needs.

Do you need a specific measuring solution? Don't hesitate to challenge us!



RECOGNIZED KNOW-HOW AND QUALITY

Through our development centers in Switzerland and the United States, Magtrol is constantly designing and developing new solutions in the field of measurement.

By following strict criteria of reliability and quality, we design robust and easy-to-use products. All our technological innovations are managed in-house.

This allows us to benefit from the experience of all our employees and to develop synergies between the different parts of our systems (software, electronics, electromechanics, etc.).

This structure also allows us to respond to requests from various fields, and to provide support to our customers in innovative projects.



COMPETENCES AND TECHNOLOGY

To guarantee the quality of our products, we maintain a rigorous manufacturing environment.

Magtrol is fortunate to be able to count on experienced and conscientious employees. Thanks to their skill and professionalism, Magtrol Group is able to provide highly reliable products that can be used in severe (offshore), demanding (people transportation) or high precision (laboratory) environments.

We are proud that Magtrol's name and products stand for quality, high reliability and technology!



Mobile toolkit application

Find us in your app store. Magtrol Mobile App helps you to easily calculate Motor Power, Torque, Power Factor and Temperature Rise by Resistance. The App also includes converter tools for Torque, Length, Temperature, Mass, Force, and Power Units.



Get the App

At your service all over the world

Magtrol Group has been in the global sensor business for many decades. Over the years we have built a strong relationship with our customers, either directly or through our professional and highly qualified sales and distribution network.

Our main partners have been in collaboration with us for many years. Together, this has allowed us to gain hands-on experience and build strong relationships with our customers.

Being a global company, Magtrol Group is never far from you, either with direct contacts or through over 20 distributors ensuring a close relationship and individual support including visits, commissioning and training.

Magtrol sales network serves over 10 000 customers around the world and offers documentation translated in many languages.



FOR A CONSTANT MEASUREMENT, CALIBRATE YOUR PRODUCTS REGULARLY

To ensure correct operation of the sensor and long-term measurement consistency, it is recommended to calibrate the sensor regularly. Magtrol recommends a factory calibration (e.g. in Magtrol's ISO 17025 accredited laboratory) every 12 months.

Returning the sensor directly to the Magtrol factory is both advantageous and economical. We can guarantee a dedicated calibration for the sensor performed by one of our specialists. In addition, any wear and tear requiring maintenance will be immediately taken care of by our after-sales service team.



Our main concern is your satisfaction

At Magtrol, we make it a point of honor to provide the highest quality after-sales service possible.

Whether it's for maintenance, upgrades or repairs, our staff is at your service to advise you or answer your questions. Our service department is available through digital means or travels worldwide to assist you.

Our service centers in the United States and Switzerland will repair your products with the utmost care and in a timely manner. During each service visit we perform a thorough examination of the product. This allows us to point out possible wear and tear due to misuse or to anticipate natural wear and tear that could disturb the measuring accuracy.





Magtrol Inc.

70 Gardenville Parkway
Buffalo, NY 14224 | USA
phone +1 716 668 55 55
fax +1 716 668 87 05
e-mail magtrol@magtrol.com

Magtrol S.A.

Rte de Montena 77
1728 Rossens | Switzerland
phone +41 26 407 30 00
fax +41 26 407 30 01
e-mail magtrol@magtrol.ch

Subsidiaries

 Germany, France
India & China
 Worldwide Network
of Sales Agents

www.magtrol.com

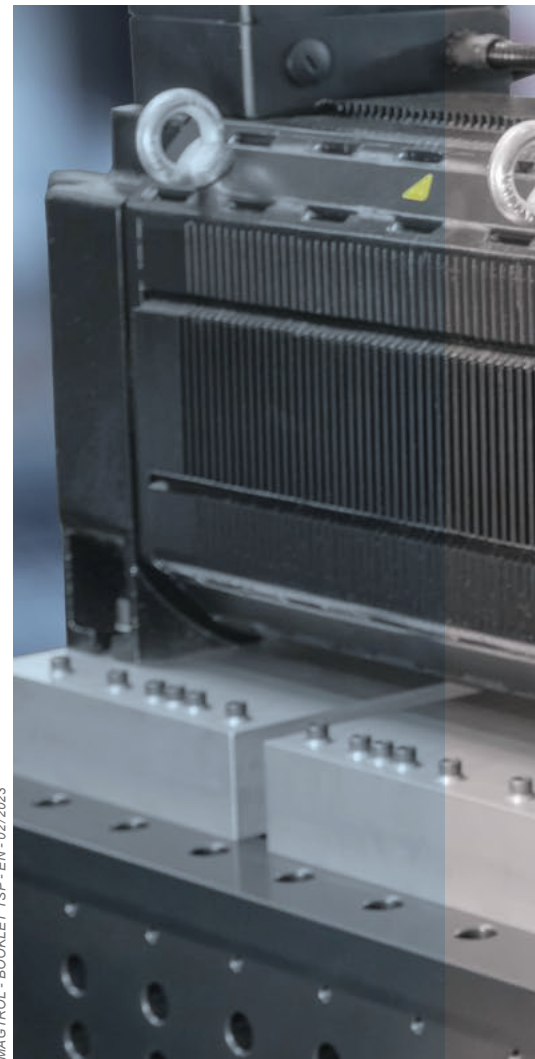

MAGTROL - BOOKLET TSP - EN - 02/2023

